

新品上市

# 2013 NEW PRODUCT



P1 CH-804E



P2 CH-804H



P14 CH-2616RB/2622RB/2629RB



P12 CH-404RL-ADU



P14 CH-274ARB

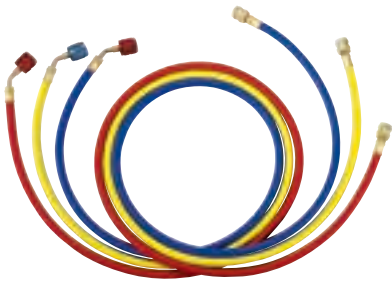

P26 CH-336RYB-SAS

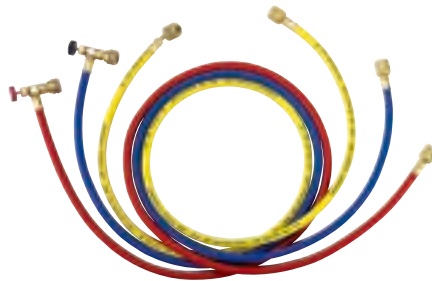

P27 CH-336RYB-CV



P51 RNN-03 x 04



P17 CH-STW-04/06



P16 DT-BT45118



P16 DT-100-45BT



P16 DT-200-45



P48 CH-6004N

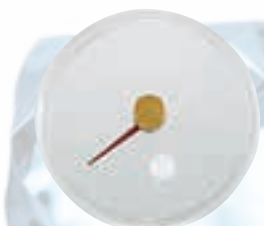

P38 OPRGEC-WP



P38 DG-VM



P20 TR1163.AL.J9



P20 TR1068.A12.J9



P34 MPG-2474H



P55 388 IR



P40 CH-134L-80MM-34



P40 CH-134H-80MM-34



P39 CH-134L-3417



P39 CH-134H-3417



P39 CH-134L-3421



P39 CH-134H-3421

# INDEX

<b>new</b>	FLARING TOOL 擴管器系列 .....	01
	TUBE EXPANDER 漲管器系列 .....	09
	TUBE BENDER 彎管器系列 .....	12
<b>new</b>	TUBE CUTTER 切管刀系列 .....	14
	CUTTER/BLADE KIT 切管刀/刀片 .....	15
<b>new</b>	DEBURRING TOOL 毛邊刀 .....	16
<b>new</b>	REAMER/TORQUE WRENCH/AC CLUTCH TOOL 絞刀/扭力扳手/離合器及壓縮機工具系列 .....	17
	SPRING BENDER/SERVICE TOOL 彈簧彎管器/手工具 .....	18
	RATCHET WRENCH/AVIATION/SNIP/CLAMP/PLIERS 棘輪扳手/鐵片剪刀/夾鉗系列工具 .....	19
<b>new</b>	UV INSPECTION KIT/SPRING LOCK COUPLING/CORE TOOL/LEAK DETECTION INJECTOR UV探測工具/接管工具/閥蕊裝拆工具/測漏注射工具 .....	20
	VALVE CORE INSTALLER&REMOVER/SHUT-OFF BALL VALVE 閥蕊裝拆工具/球閥開關 .....	21
	HOSE-SEAL, GASKET&CORE KIT/PIPELINE CONNECTOR 修理包組/管路測漏接頭組/蓋子組 .....	22
	QUICK COUPLER 快速接頭 .....	24
	AUTO SHUT-OFF VALVE ADAPTER 自動開關閥接頭 .....	25
<b>new</b>	CHARGING HOSE 冷媒管 .....	26
<b>new</b>	MANIFOLD/MANIFOLD SPARE PARTS 錶組系列/錶架零件 .....	30
<b>new</b>	GAUGE 冷媒錶 .....	38
	LATCH/HINGE/VENTILATOR 冷凍庫把手/鉸鏈/通風窗 .....	42
	SOLDER UNION/SIGHT GLASS/CAPILLARY 沖灌閥/視窗/毛細管組 .....	47
	FLOW SWITCH/VALVE/CAN TAP VALVE 水流開關/閥系列/開關器 .....	48
<b>new</b>	BRASS NUT/FITTING/ADAPTER 銅頭/接頭/轉接頭 .....	51
<b>new</b>	COPPER SEAL CAP/THERMOMETER/METER/DRIER/PRESSURE SWITCH 紅銅帽系列/溫度計/鉤錶/風速計/冷媒測漏儀/過濾器/壓力開關 .....	52
	ACCUMULATOR/DRIER/OIL SEPARATOR/RECEIVER&HEAT-EXCHANGER/CONDENSER/OTHER 液分離器/乾燥筒/油分離器/儲液器&冷熱交換器/冷卻器/其他 .....	61



# 偏心式擴管器系列-棘輪氣電動省力型 RATCHET AND DRILL POWERED LESS POWER, 45° ECCENTRIC CONE TYPE FLARING TOOL

BAR CAN BE CHOSEN TO SHOW R410 or TO COLOR WHITE DIRECTION 底座可選漆白字及R410專用  
45° STEEL/ALUMINUM ECCENTRIC CONE TYPE FLARING TOOL-AIR WRENCH BIT 鐵製及鋁合金氣電動型偏心式擴管器



Steel 鐵製 (E)

Aluminum 鋁製 (EU)

Set (L, Optional) 整組可選配

\*\* Optional for O.D. tubing: 6.8.10.12.14.16.18mm選配

ITEM	CH-804E	CH-804EU	CH-804EL	CH-804EUL
MATERIAL 材質	Steel 鐵	Aluminum 鋁	Steel 鐵	Aluminum 鋁
O.D. TUBING	1/4", 3/8", 1/2", 5/8"			
INCLUDE 內含	CH-274 Tube Cutter切管刀 CH-208 Reamer絞刀 Carrying Case 附吹氣盒			

ITEM	CH-805E	CH-805EU	CH-805EL	CH-805EUL
MATERIAL 材質	Steel 鐵	Aluminum 鋁	Steel 鐵	Aluminum 鋁
O.D. TUBING	1/4", 3/8", 1/2", 5/8", 3/4"			
INCLUDE 內含	CH-274 Tube Cutter切管刀 CH-208 Reamer絞刀 Carrying Case 附吹氣盒			

ITEM	CH-806E	CH-806EU	CH-806EL	CH-806EUL
MATERIAL 材質	Steel 鐵	Aluminum 鋁	Steel 鐵	Aluminum 鋁
O.D. TUBING	1/4", 5/16", 3/8", 1/2", 5/8", 3/4"			
INCLUDE 內含	CH-274 Tube Cutter切管刀 CH-208 Reamer絞刀 Carrying Case 附吹氣盒			

ITEM	CH-808E	CH-808EU	CH-808EL	CH-808EUL
MATERIAL 材質	Steel 鐵	Aluminum 鋁	Steel 鐵	Aluminum 鋁
O.D. TUBING	3/16", 1/4", 5/16", 3/8", 1/2", 5/8", 3/4"			
INCLUDE 內含	CH-274 Tube Cutter切管刀 CH-208 Reamer絞刀 Carrying Case 附吹氣盒			

ITEM	CH-808EM	CH-808EMU	CH-808EML	CH-808EMUL	CH-809EML	CH-809EMUL
MATERIAL 材質	Steel 鐵	Aluminum 鋁	Steel 鐵	Aluminum 鋁	Steel 鐵	Aluminum 鋁
O.D. TUBING	6, 8, 10, 12, 14, 16, 19				6, 8, 10, 12, 14, 16, 19 1/4", 5/16", 3/8", 1/2", 5/8", 3/4"	
INCLUDE 內含					CH-274 Tube Cutter切管刀 CH-208 Reamer絞刀 Carrying Case 附吹氣盒	



# 偏心式擴管器系列-氣電動型 WITH 1/2"\*6mm HEX AIR WRENCH BIT LESS POWER, 45° ECCENTRIC CONE TYPE FLARING TOOL

BAR CAN BE CHOSEN TO SHOW R410 or TO COLOR WHITE DIRECTION 底座可選漆白字及R410專用  
45° STEEL/ALUMINUM ECCENTRIC CONE TYPE FLARING TOOL-AIR WRENCH BIT 鐵製及鋁合金氣電動型偏心式擴管器



Steel 鐵製 (H)

Aluminum 鋁製 (HU)

Set (L, Optional) 整組可選配

\*\* Optional for O.D. tubing: 6.8.10.12.14.16.18mm選配

ITEM	CH-804H	CH-804HU	CH-804HL	CH-804HUL
MATERIAL 材質	Steel 鐵	Aluminum 鋁	Steel 鐵	Aluminum 鋁
O.D. TUBING	1/4", 3/8", 1/2", 5/8"			
INCLUDE 內含	CH-274 Tube Cutter切管刀 CH-208 Reamer絞刀 Carrying Case 附吹氣盒			

ITEM	CH-805H	CH-805HU	CH-805HL	CH-805HUL
MATERIAL 材質	Steel 鐵	Aluminum 鋁	Steel 鐵	Aluminum 鋁
O.D. TUBING	1/4", 3/8", 1/2", 5/8", 3/4"			
INCLUDE 內含	CH-274 Tube Cutter切管刀 CH-208 Reamer絞刀 Carrying Case 附吹氣盒			

ITEM	CH-806H	CH-806HU	CH-806HL	CH-806HUL
MATERIAL 材質	Steel 鐵	Aluminum 鋁	Steel 鐵	Aluminum 鋁
O.D. TUBING	1/4", 5/16", 3/8", 1/2", 5/8", 3/4"			
INCLUDE 內含	CH-274 Tube Cutter切管刀 CH-208 Reamer絞刀 Carrying Case 附吹氣盒			

ITEM	CH-808H	CH-808HU	CH-808HL	CH-808HUL
MATERIAL 材質	Steel 鐵	Aluminum 鋁	Steel 鐵	Aluminum 鋁
O.D. TUBING	3/16", 1/4", 5/16", 3/8", 1/2", 5/8", 3/4"			
INCLUDE 內含	CH-274 Tube Cutter切管刀 CH-208 Reamer絞刀 Carrying Case 附吹氣盒			

ITEM	CH-808HM	CH-808HMU	CH-808HML	CH-808HMUL	CH-809HML	CH-809HMUL
MATERIAL 材質	Steel 鐵	Aluminum 鋁	Steel 鐵	Aluminum 鋁	Steel 鐵	Aluminum 鋁
O.D. TUBING	6, 8, 10, 12, 14, 16, 19				6, 8, 10, 12, 14, 16, 19 1/4", 5/16", 3/8", 1/2", 5/8", 3/4"	
INCLUDE 內含	CH-274 Tube Cutter切管刀 CH-208 Reamer絞刀 Carrying Case 附吹氣盒					



# 偏心式擴管器系列-氣動型 WITH 1/2" AIR WRENCH BIT

## LESS POWER, 45° ECCENTRIC CONE TYPE FLARING TOOL

BAR CAN BE CHOSEN TO SHOW R410 or TO COLOR WHITE DIRECTION 底座可選漆白字及R410專用  
 45° STEEL/ALUMINUM ECCENTRIC CONE TYPE FLARING TOOL-AIR WRENCH BIT 鐵製及鋁合金氣動型偏心式擴管器



Steel 鐵製 (B)

Aluminum 鋁製 (BU)

Set (L, Optional) 整組可選配

\*\* Optional for O.D. tubing: 6.8.10.12.14.16.18mm選配

ITEM	CH-804B	CH-804BU	CH-804BL	CH-804BUL
MATERIAL 材質	Steel 鐵	Aluminum 鋁	Steel 鐵	Aluminum 鋁
O.D. TUBING	1/4", 3/8", 1/2", 5/8"			
INCLUDE 內含	CH-274 Tube Cutter切管刀 CH-208 Reamer絞刀 Carrying Case 附吹氣盒			

ITEM	CH-805B	CH-805BU	CH-805BL	CH-805BUL
MATERIAL 材質	Steel 鐵	Aluminum 鋁	Steel 鐵	Aluminum 鋁
O.D. TUBING	1/4", 3/8", 1/2", 5/8", 3/4"			
INCLUDE 內含	CH-274 Tube Cutter切管刀 CH-208 Reamer絞刀 Carrying Case 附吹氣盒			

ITEM	CH-806B	CH-806BU	CH-806BL	CH-806BUL
MATERIAL 材質	Steel 鐵	Aluminum 鋁	Steel 鐵	Aluminum 鋁
O.D. TUBING	1/4", 5/16", 3/8", 1/2", 5/8", 3/4"			
INCLUDE 內含	CH-274 Tube Cutter切管刀 CH-208 Reamer絞刀 Carrying Case 附吹氣盒			

ITEM	CH-808B	CH-808BU	CH-808BL	CH-808BUL
MATERIAL 材質	Steel 鐵	Aluminum 鋁	Steel 鐵	Aluminum 鋁
O.D. TUBING	3/16", 1/4", 5/16", 3/8", 1/2", 5/8", 3/4"			
INCLUDE 內含	CH-274 Tube Cutter切管刀 CH-208 Reamer絞刀 Carrying Case 附吹氣盒			

ITEM	CH-808BM	CH-808BMU	CH-808BML	CH-808BMUL	CH-809BML	CH-809BMUL
MATERIAL 材質	Steel 鐵	Aluminum 鋁	Steel 鐵	Aluminum 鋁	Steel 鐵	Aluminum 鋁
O.D. TUBING	6, 8, 10, 12, 14, 16, 19				6, 8, 10, 12, 14, 16, 19 1/4", 5/16", 3/8", 1/2", 5/8", 3/4"	
INCLUDE 內含					CH-274 Tube Cutter切管刀 CH-208 Reamer絞刀 Carrying Case 附吹氣盒	

# 偏心式擴管器系列-棘輪扳手

WITH 1/2" RATCHET WRENCH BIT

LESS POWER, 45° ECCENTRIC CONE TYPE FLARING TOOL

BAR CAN BE CHOSEN TO SHOW R410 or TO COLOR WHITE DIRECTION 底座可選漆白字及R410專用

45° STEEL/ALUMINUM ECCENTRIC CONE TYPE FLARING TOOL- RATCHET WRENCH BIT 鐵製及鋁合金棘輪扳手偏心式擴管器



Steel 鐵製 (W)

Aluminum 鋁製 (WU)

Set (L, Optional) 整組可選配

\*\* Optional for O.D. tubing: 6.8.10.12.14.16.18mm選配

ITEM	CH-804W	CH-804WU	CH-804WL	CH-804WUL
MATERIAL 材質	Steel 鐵	Aluminum 鋁	Steel 鐵	Aluminum 鋁
O.D. TUBING	1/4", 3/8", 1/2", 5/8"			
INCLUDE 內含	CH-274 Tube Cutter切管刀 CH-208 Reamer絞刀 Carrying Case 附吹氣盒			

ITEM	CH-805W	CH-805WU	CH-805WL	CH-805WUL
MATERIAL 材質	Steel 鐵	Aluminum 鋁	Steel 鐵	Aluminum 鋁
O.D. TUBING	1/4", 3/8", 1/2", 5/8", 3/4"			
INCLUDE 內含	CH-274 Tube Cutter切管刀 CH-208 Reamer絞刀 Carrying Case 附吹氣盒			

ITEM	CH-806W	CH-806WU	CH-806WL	CH-806WUL
MATERIAL 材質	Steel 鐵	Aluminum 鋁	Steel 鐵	Aluminum 鋁
O.D. TUBING	1/4", 5/16", 3/8", 1/2", 5/8", 3/4"			
INCLUDE 內含	CH-274 Tube Cutter切管刀 CH-208 Reamer絞刀 Carrying Case 附吹氣盒			

ITEM	CH-808W	CH-808WU	CH-808WL	CH-808WUL
MATERIAL 材質	Steel 鐵	Aluminum 鋁	Steel 鐵	Aluminum 鋁
O.D. TUBING	3/16", 1/4", 5/16", 3/8", 1/2", 5/8", 3/4"			
INCLUDE 內含	CH-274 Tube Cutter切管刀 CH-208 Reamer絞刀 Carrying Case 附吹氣盒			

ITEM	CH-808WM	CH-808WMU	CH-808WML	CH-808WMUL	CH-809WML	CH-809WMUL
MATERIAL 材質	Steel 鐵	Aluminum 鋁	Steel 鐵	Aluminum 鋁	Steel 鐵	Aluminum 鋁
O.D. TUBING	6, 8, 10, 12, 14, 16, 19				6, 8, 10, 12, 14, 16, 19 1/4", 5/16", 3/8", 1/2", 5/8", 3/4"	
INCLUDE 內含	CH-274 Tube Cutter切管刀 CH-208 Reamer絞刀 Carrying Case 附吹氣盒					

# 偏心式擴管器系列-單向軸承省力型 — Single Axial Bearing Type & Easy-to-Use

## LESS POWER, 45° ECCENTRIC CONE TYPE FLARING TOOL

BAR CAN BE CHOSEN TO SHOW R410 or TO COLOR WHITE DIRECTION 底座可選漆白字及R410專用  
45° STEEL/ALUMINUM ECCENTRIC CONE TYPE FLARING TOOL 鐵製及鋁合金偏心式省力擴管器



Steel 鐵製 (A)

Aluminum 鋁製 (AU)

Set (L, Optional) 整組可選配

\*\* Optional for O.D. tubing: 6.8.10.12.14.16.18mm選配

ITEM	CH-704A	CH-704AU	CH-704AL	CH-704AUL
MATERIAL 材質	Steel 鐵	Aluminum 鋁	Steel 鐵	Aluminum 鋁
O.D. TUBING	1/4", 3/8", 1/2", 5/8"			
INCLUDE 內含	CH-274 Tube Cutter切管刀 CH-208 Reamer絞刀 Carrying Case 附吹氣盒			

ITEM	CH-705A	CH-705AU	CH-705AL	CH-705AUL
MATERIAL 材質	Steel 鐵	Aluminum 鋁	Steel 鐵	Aluminum 鋁
O.D. TUBING	1/4", 3/8", 1/2", 5/8", 3/4"			
INCLUDE 內含	CH-274 Tube Cutter切管刀 CH-208 Reamer絞刀 Carrying Case 附吹氣盒			

ITEM	CH-706A	CH-706AU	CH-706AL	CH-706AUL
MATERIAL 材質	Steel 鐵	Aluminum 鋁	Steel 鐵	Aluminum 鋁
O.D. TUBING	1/4", 5/16", 3/8", 1/2", 5/8", 3/4"			
INCLUDE 內含	CH-274 Tube Cutter切管刀 CH-208 Reamer絞刀 Carrying Case 附吹氣盒			

ITEM	CH-708A	CH-708AU	CH-708AL	CH-708AUL
MATERIAL 材質	Steel 鐵	Aluminum 鋁	Steel 鐵	Aluminum 鋁
O.D. TUBING	3/16", 1/4", 5/16", 3/8", 1/2", 5/8", 3/4"			
INCLUDE 內含	CH-274 Tube Cutter切管刀 CH-208 Reamer絞刀 Carrying Case 附吹氣盒			

ITEM	CH-708M	CH-708MU	CH-708ML	CH-708MUL	CH-709AML	CH-709AMUL
MATERIAL 材質	Steel 鐵	Aluminum 鋁	Steel 鐵	Aluminum 鋁	Steel 鐵	Aluminum 鋁
O.D. TUBING	6, 8, 10, 12, 14, 16, 19				6, 8, 10, 12, 14, 16, 19 1/4", 5/16", 3/8", 1/2", 5/8", 3/4"	
INCLUDE 內含	CH-274 Tube Cutter切管刀 CH-208 Reamer絞刀 Carrying Case 附吹氣盒					



# 偏心式擴管器系列

## LESS POWER, 45° ECCENTRIC CONE TYPE FLARING TOOL

BAR CAN BE CHOSEN TO SHOW R410 or TO COLOR WHITE DIRECTION 底座可選漆白字及R410專用  
45° STEEL/ALUMINUM ECCENTRIC CONE TYPE FLARING TOOL 鐵製及鋁合金偏心式省力擴管器



Steel 鐵製 (A)

Aluminum 鋁製 (AU)

Set (L, Optional) 整組可選配

\*\* Optional for O.D. tubing: 6.8.10.12.14.16.18mm選配

ITEM	CH-804A	CH-804AU	CH-804AL	CH-804AUL
MATERIAL 材質	Steel 鐵	Aluminum 鋁	Steel 鐵	Aluminum 鋁
O.D. TUBING	1/4", 3/8", 1/2", 5/8"			
INCLUDE 內含	CH-274 Tube Cutter切管刀 CH-208 Reamer絞刀 Carrying Case 附吹氣盒			

ITEM	CH-805A	CH-805AU	CH-805AL	CH-805AUL
MATERIAL 材質	Steel 鐵	Aluminum 鋁	Steel 鐵	Aluminum 鋁
O.D. TUBING	1/4", 3/8", 1/2", 5/8", 3/4"			
INCLUDE 內含	CH-274 Tube Cutter切管刀 CH-208 Reamer絞刀 Carrying Case 附吹氣盒			

ITEM	CH-806A	CH-806AU	CH-806AL	CH-806AUL
MATERIAL 材質	Steel 鐵	Aluminum 鋁	Steel 鐵	Aluminum 鋁
O.D. TUBING	1/4", 5/16", 3/8", 1/2", 5/8", 3/4"			
INCLUDE 內含	CH-274 Tube Cutter切管刀 CH-208 Reamer絞刀 Carrying Case 附吹氣盒			

ITEM	CH-808A	CH-808AU	CH-808AL	CH-808AUL
MATERIAL 材質	Steel 鐵	Aluminum 鋁	Steel 鐵	Aluminum 鋁
O.D. TUBING	3/16", 1/4", 5/16", 3/8", 1/2", 5/8", 3/4"			
INCLUDE 內含	CH-274 Tube Cutter切管刀 CH-208 Reamer絞刀 Carrying Case 附吹氣盒			

ITEM	CH-808M	CH-808MU	CH-808ML	CH-808MUL	CH-809AML	CH-809AMUL
MATERIAL 材質	Steel 鐵	Aluminum 鋁	Steel 鐵	Aluminum 鋁	Steel 鐵	Aluminum 鋁
O.D. TUBING	6, 8, 10, 12, 14, 16, 19				6, 8, 10, 12, 14, 16, 19 1/4", 5/16", 3/8", 1/2", 5/8", 3/4"	
INCLUDE 內含	CH-274 Tube Cutter切管刀 CH-208 Reamer絞刀 Carrying Case 附吹氣盒					

# 偏心式擴管器系列-棘輪省力型

## LESS POWER, 45° ECCENTRIC CONE TYPE FLARING TOOL

BAR CAN BE CHOSEN TO SHOW R410 or TO COLOR WHITE DIRECTION 底座可選漆白字及R410專用  
 45° STEEL/ALUMINUM RATCHET ECCENTRIC CONE TYPE FLARING TOOL 鐵製及鋁合金棘輪式省力擴管器



Steel 鐵製 (R)

Aluminum 鋁製 (RU)

Set (L, Optional) 整組可選配

\*\* Optional for deburring tool: DT-200/200C/200RA/300/300C/300RA毛邊刀選配  
 \*\* Optional for O.D. tubing: 6.8.10.12.14.16.18mm選配

ITEM	CH-804R	CH-804RU	CH-804RL	CH-804RUL
MATERIAL 材質	Steel 鐵	Aluminum 鋁	Steel 鐵	Aluminum 鋁
O.D. TUBING	1/4", 3/8", 1/2", 5/8"			
INCLUDE 內含	CH-274 Tube Cutter切管刀 DT-200RA Deburring Tool毛邊刀 Carrying Case 附吹氣盒			

ITEM	CH-805R	CH-805RU	CH-805RL	CH-805RUL
MATERIAL 材質	Steel 鐵	Aluminum 鋁	Steel 鐵	Aluminum 鋁
O.D. TUBING	1/4", 3/8", 1/2", 5/8", 3/4"			
INCLUDE 內含	CH-274 Tube Cutter切管刀 DT-200RA Deburring Tool毛邊刀 Carrying Case 附吹氣盒			

ITEM	CH-806R	CH-806RU	CH-806RL	CH-806RUL
MATERIAL 材質	Steel 鐵	Aluminum 鋁	Steel 鐵	Aluminum 鋁
O.D. TUBING	1/4", 5/16", 3/8", 1/2", 5/8", 3/4"			
INCLUDE 內含	CH-274 Tube Cutter切管刀 DT-200RA Deburring Tool毛邊刀 Carrying Case 附吹氣盒			

ITEM	CH-808R	CH-808RU	CH-808RL	CH-808RUL
MATERIAL 材質	Steel 鐵	Aluminum 鋁	Steel 鐵	Aluminum 鋁
O.D. TUBING	3/16", 1/4", 5/16", 3/8", 1/2", 5/8", 3/4"			
INCLUDE 內含	CH-274 Tube Cutter切管刀 DT-200RA Deburring Tool毛邊刀 Carrying Case 附吹氣盒			

ITEM	CH-808RM	CH-808RMU	CH-808RML	CH-808RMUL	CH-809RML	CH-809RMUL
MATERIAL 材質	Steel 鐵	Aluminum 鋁	Steel 鐵	Aluminum 鋁	Steel 鐵	Aluminum 鋁
O.D. TUBING	6, 8, 10, 12, 14, 16, 19				6, 8, 10, 12, 14, 16, 19 1/4", 5/16", 3/8", 1/2", 5/8", 3/4"	
INCLUDE 內含	CH-274 Tube Cutter切管刀 DT-200RA Deburring Tool毛邊刀 Carrying Case 附吹氣盒					

# 擴管器系列

BEST QUALITY FLARING TOOL



擠壓式擴管及漲管器

## ▶▶ CH-604AL

W/CH-274 tube cutter, CH-208 reamer  
1/4", 3/8", 1/2", 5/8" O.D. tubing.

## ▶▶ CH-605AL

W/CH-274 tube cutter, CH-208 reamer  
1/4", 3/8", 1/2", 5/8", 3/4" O.D. tubing.

## ▶▶ CH-606AL

W/CH-274 tube cutter, CH-208 reamer  
1/4", 5/16", 3/8", 1/2", 5/8", 3/4" O.D. tubing.

## ▶▶ CH-608AL

W/CH-274 tube cutter, CH-208 reamer  
3/16", 1/4", 5/16", 3/8", 1/2", 5/8", 3/4" O.D. tubing.

## ▶▶ CH-608ML

W/CH-274 tube cutter, CH-208 reamer  
6, 8, 10, 12, 14, 16, 19mm O.D. tubing.

**\*\* 6, 8, 10, 12, 14, 16, 18 mm, optional \*\***



## ▶▶ CH-609AML

W/CH-274 tube cutter, CH-208 reamer  
6, 8, 10, 12, 14, 16, 19mm O.D. bar  
1/4", 5/16", 3/8", 1/2", 5/8", 3/4" O.D. tubing.

**\*\* 6, 8, 10, 12, 14, 16, 18 mm, optional \*\***



擠壓式擴管器

## ▶▶ CH-203

Flaring tool  
size for 5/8", 3/4", 7/8"  
and 1- 1/8" O.D. tubing



擠壓式擴管器

## ▶▶ CH-195

for 3/16", 1/4", 5/16", 3/8",  
7/16", 1/2" and 5/8" O.D.  
tubing.

底座 BAR CH-195-7

## ▶▶ CH-195M

for 4, 6, 8, 10, 12, 14 & 16mm  
O.D. tubing.

底座 BAR CH-195-7M

**\*\* 4, 6, 8, 10, 12, 15, 16mm,  
optional \*\***



鑽石型擴管器

## ▶▶ CH-504A

1/4", 3/8", 1/2", 5/8" O.D. tubing.

## ▶▶ CH-505A

1/4", 3/8", 1/2", 5/8", 3/4" O.D. tubing.

## ▶▶ CH-506A

1/4", 5/16", 3/8", 1/2", 5/8", 3/4" O.D. tubing.

## ▶▶ CH-508A

3/16", 1/4", 5/16", 3/8", 1/2", 5/8", 3/4" O.D. tubing.

## ▶▶ CH-508M

6, 8, 10, 12, 14, 16, 19mm O.D. tubing.

**\*\* 6, 8, 10, 12, 14, 16, 18 mm O.D. tubing bar optional \*\***



推擠式鑽石型擴管器

## ▶▶ CH-500 / 底座CT-500BAR

For 3/16", 1/4", 5/16", 3/8", 1/2", 5/8"  
O.D. tubing.

## ▶▶ CH-500M / 底座CT-500MBAR

For 6, 8, 10, 12, 16mm O.D. tubing.



抓式鑽石型擴管器

## ▶▶ CH-525

For 3/16" ~ 5/8" O.D. tubing.  
One opening hold for all sizes.



# 傳統式擴管及漲管器 FLARING TOOL

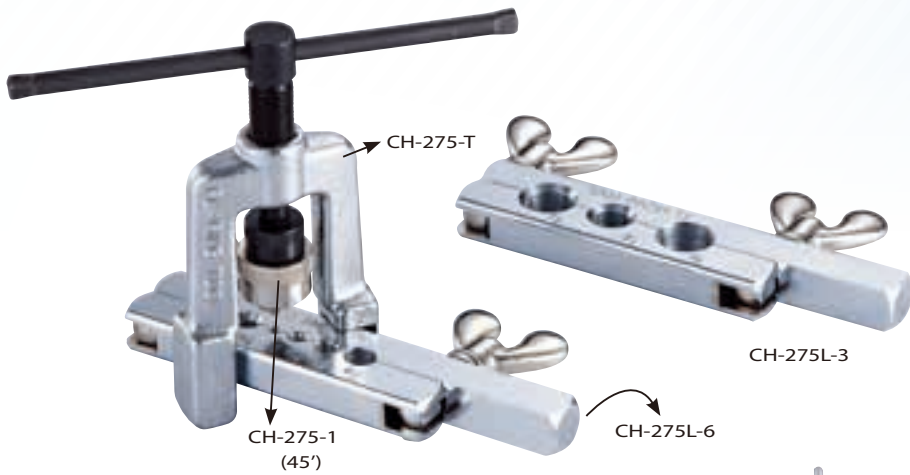

- ▶▶ **CH-275L**  
Same as CH-275 and with hand carrying case.
- ▶▶ **CH-275LM**  
Metric size, for 4, 4.75, 6, 8, 10, 12, 14, 16 & 19mm.

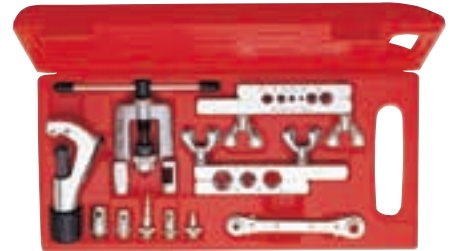

- ▶▶ **CH-278L**  
Contains of kit : CH-275 flaring & swaging tool. CH-274 tube cutter, CH-122 ratchet wrench in plastic case.
- ▶▶ **CH-278LM**  
Contains of kit : CH-275M flaring & swaging tool. CH-274 tube cutter, CH-122mm(6, 8, 10, 12mm) ratchet wrench in plastic case.



- ▶▶ **CH-275**  
Flare 1/8", 3/16", 1/4", 5/16", 3/8", 7/16", 1/2", 5/8", and 3/4" O.D.  
(1/8", 1/4", 3/8", 1/2", 5/8", nom.)  
Include 5 swage adapters which cover 3/16", 1/4", 5/16", 3/8", 1/2", 5/8", 3/4", (1/8", 1/4", 3/8", 1/2" 5/8" nom.) in plastic box
- ▶▶ **CH-275M**  
Metric size, for 4, 4.75, 6, 8, 10, 12, 14, 16 & 19mm.



- ▶▶ **CH-1226**  
Contains of kit : CH-274 tube cutter CH-195 flaring tool.
- ▶▶ **CH-1226M**  
Contains of kit : CH-274 tube cutter CH-195M flaring tool.



- ▶▶ **CH-203L**  
CH-203 w/CH-312 cutter & CH-208 Reamer. With hand carrying case.

# 雙層式擴管器 DOUBLE FLARING TOOL

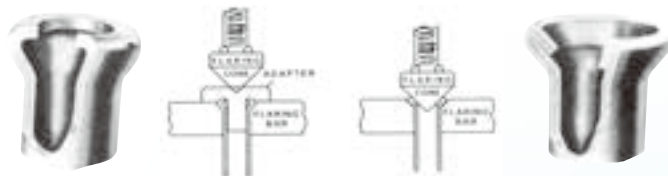

Screwing down flaring cone with proper adapter, Screwing back flaring cone to remove adapter, flared finished.

- ▶▶ **CH-268FB**  
For 3/16", 1/4", 5/16", 3/8", 1/2" O.D. tubing. w/CH-274 & 5 double flare adapters.

# 手動漲管器系列

## MULTI SIZES TUBE EXPANDER



### 鋁合金漲管頭

#### ALUMINUM EXPAND HEADS

- ▶▶ **CH-1100AE Aluminum Expand Heads**  
For 1/4", 5/16", 3/8", 1/2", 5/8", 3/4", 7/8", 1", 1-1/8", 1-1/4", 1-3/8", 1-1/2", 1-5/8" O.D. tubing.
- ▶▶ **CH-2200AE Aluminum Expand Heads**  
For 6, 8, 10, 12, 14, 15, 16, 18, 19, 22, 28, 29, 32, 35, 38, 42mm O.D. tubing.



CH-1100A-ALLW0405



### Aluminum 鋁製

Kit includes CH-1100ASH handle (Length is 320mm), DT-200 deburring tool, and CH-1100AE aluminum expand heads. Complete kit in a plastic hand carrying case.

- ▶▶ **CH-1100AS INCH SIZE**  
6 Sizes: 1/4", 5/16", 3/8", 1/2", 5/8", 3/4"

### Aluminum 鋁製

Kit includes CH-1100AH handle (Length is 405mm), DT-200 deburring tool, CH-312 tube cutter 1/4"~1-5/8" and CH-1100AE aluminum expand heads. Complete kit in a plastic hand carrying case.

- ▶▶ **CH-1100A INCH SIZE**  
6 Sizes: 3/8", 1/2", 5/8", 3/4", 7/8" & 1"
- \*\* **OPTIONAL FOR INCH SIZE: 1/4", 5/16", 1-1/8", 1-1/4", 1-1/2", 1-3/8", 1-5/8" \*\***
- ▶▶ **CH-2200A MM SIZE**  
6 Sizes: 10, 12, 15, 16, 18 & 22mm
- \*\* **OPTIONAL FOR MM SIZE: 6, 8, 14, 19, 28, 29, 32, 35, 38 and 42mm \*\***



### 鐵製漲管頭

#### STEEL EXPAND HEADS

- ▶▶ **CH-1000E Steel Expand Heads**  
For 3/8", 1/2", 5/8", 3/4", 7/8", & 1", 1-1/8", 1-1/4", 1-1/2", 1-3/8", 1-5/8" O.D. tubing.
- ▶▶ **CH-2000E Steel Expand Heads**  
For 10, 12, 14, 15, 16, 18, 19, 22, 28, 35, 38, 42mm O.D. tubing.

### Steel 鐵製

Kit include CH-1000H handle, CH-208 plastic reamer 3/16"~1-1/2" (5mm~38mm) Complete kit in a steel hand carrying case.

- ▶▶ **CH-1000 INCH SIZE**  
6 sizes: 3/8", 1/2", 5/8", 3/4", 7/8" & 1" O.D. tubing.
- \*\* **Expand heads 1-1/8", 1-1/4", 1-1/2", 1-3/8", 1-5/8" optional \*\***
- ▶▶ **CH-2000 MM SIZE**  
6 sizes: 10, 12, 15, 16, 18 & 22mm
- \*\* **Expand heads 14, 19, 28, 35, 38, 42mm optional \*\***





## → 手動漲管器系列 MULTI SIZES TUBE EXPANDER



### Steel 鐵製

Kit includes CH-1000H handle, CH-208 plastic reamer, CH-312 tube cutter 1/4"~1-5/8". Complete kit in a plastic hand carrying case.

#### ▶▶ CH-1000-PC INCH SIZE

6 sizes: 3/8", 1/2", 5/8", 3/4", 7/8" & 1" O.D. tubing.

\*\* Expand heads 1-1/8", 1-1/4", 1-1/2", 1-3/8", 1-5/8" optional \*\*

#### ▶▶ CH-2000-PC MM SIZE

6 sizes: 10, 12, 15, 16, 18 & 22mm O.D. tubing.

\*\* Expand heads 14, 19, 28, 35, 38, 42mm optional \*\*



### Steel 鐵製

Kit includes CH-1000H handle, CH-208 plastic reamer, CH-312 tube cutter 1/4"~1-5/8". Complete kit in a plastic hand carrying case.

#### ▶▶ CH-1000-ALC INCH SIZE

10 Sizes: 3/8", 1/2", 5/8", 3/4", 7/8", 1", 1-1/8", 1-1/4", 1-3/8" & 1-5/8" O.D. tubing.

\*\* Expand heads 1-1/2" optional \*\*

#### ▶▶ CH-2000-ALC MM SIZE

11 Sizes: 10, 12, 14, 15, 16, 18, 22, 28, 29, 35 & 42 mm O.D. tubing.

\*\* Expand head 38mm optional \*\*

## → 電動漲管器 ELECTRONIC TUBE EXPANDER



Electronic tube expander kit, W/DT-100CRA deburring tool & 1pc plug adapter  
Complete kit in a carrying case.  
Input : 100~240V 1.5A (50/60 Hz).  
Output : DC24V 2.7A

#### ▶▶ CH-1000-EL INCH SIZE

6 sizes: 3/8", 1/2", 5/8", 3/4", 7/8", 1" O.D. tubing.

\*\* Expand heads 1-1/8", 1-1/4", 1-1/2", 1-3/8", 1-5/8" optional \*\*

#### ▶▶ CH-2000-EL MM SIZE

6 sizes: 10, 12, 15, 16, 18, 22mm

\*\* Expand heads 14, 19, 28, 35, 38, 42mm optional \*\*

### PLUG ADAPTER CHOICE:



▶▶ PA-1  
AC250V / 10A



▶▶ PA-2  
AC250V / 10A



▶▶ PA-3  
AC250V / 13A



▶▶ PA-5  
AC250V / 10A



▶▶ PA-6  
AC250V / 10A



## → 油壓漲管器 HYDRAULIC TUBE EXPANDER



Kit include hydraulic handle, W/CH-209A reamer & CH-274 cutter  
Complete kit in a carrying case.

#### ▶▶ CH-1000-HY INCH SIZE

6 sizes: 3/8", 1/2", 5/8", 3/4", 7/8", 1" O.D. tubing.

\*\* Expand heads 1-1/8", 1-1/4", 1-1/2", 1-3/8", 1-5/8" optional \*\*

#### ▶▶ CH-2000-HY MM SIZE

6 sizes: 10, 12, 15, 16, 18, 22mm

\*\* Expand heads 14, 19, 28, 35, 38, 42mm optional \*\*



# ➔ 推進式多功能彎管器組系列

## TUBE BENDER KIT

**Fit for over 0.8mm thickness copper tube, over 1/2" copper tube must over 0.8mm thickness. Otherwise, the copper tube is easy to be sunk after bending. 適用於厚度0.8mm以上的軟管。**  
**Suitable for soft copper tube. Hard copper tube must be soft annealed before bending. 使用硬銅管前請先退火軟化再操作。**



塑鋼型式  
可反向操作

▶▶ **CH-404RL**  
W/Steel reverse direction bending + CH-274 cutter + CH-208 reamer  
Size: 1/4", 5/16", 3/8", 1/2", 5/8", 3/4", 7/8" O.D. tubing.

▶▶ **CH-404RUL**  
W/Aluminum reverse direction bending + CH-274 cutter + CH-208 reamer  
Size: 1/4", 5/16", 3/8", 1/2", 5/8", 3/4", 7/8" O.D. tubing.

▶▶ **CH-505RM**  
W/Steel reverse direction bending + CH-274 cutter + CH-208 reamer  
Size: 6, 8, 10, 12, 14, 16, 18, 22mm

▶▶ **CH-505RUM**  
W/Aluminum reverse direction bending + CH-274 cutter + CH-208 reamer  
Size: 6, 8, 10, 12, 14, 16, 18, 22mm



反向座

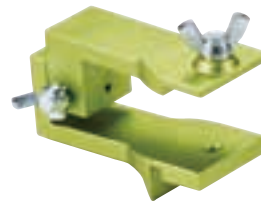

▶▶ **CH-404RL-ADU**  
ALUMINUM

▶▶ **CH-404RL-AD**  
STEEL



鋁合金型式

**\*\* Colorful aluminum bending form wheel \*\***

▶▶ **CH-404ARL**  
W/Steel reverse direction bending CH-404RL-AD  
Size: 1/4", 5/16", 3/8", 1/2", 5/8", 3/4", 7/8" O.D. tubing.

▶▶ **CH-404ARUL**  
W/Aluminum reverse direction bending CH-404RL-ADU  
Size: 1/4", 5/16", 3/8", 1/2", 5/8", 3/4", 7/8" O.D. tubing.



塑鋼型式

▶▶ **CH-404BL**  
Size: 3/8", 1/2", 5/8", 3/4", 7/8" & 1-1/8" O.D. tubing

▶▶ **CH-505BM**  
Size: 12, 14, 16, 18, 22, 29mm



▶▶ **CH-404L** 塑鋼型式

For bending 3/8", 1/2", 5/8", 3/4" and 7/8" soft tubings. Bending worked by ratchet which can save power and do more efficiency bending. Complete set includes 5 bending form wheels, tube cutter and reamer in a hand carrying case + CH-274 cutter + CH-208 reamer.

▶▶ **CH-404AL** 鋁合金型式

W/colorful ALUMINUM bending form wheels + CH-274 cutter + CH-208 reamer.

▶▶ **CH-505M** 塑鋼型式

For bending 8, 10, 12, 14, 16, 18, 22mm soft tubings. Bending worked by ratchet which can save power and do more efficiency bending. Complete set in a hand carrying case. Fit for over 0.8mm copper tube.

**\*\* Soft tubing ratchet 15mm, 20mm, optional \*\***



## 彎管器系列

Suitable for soft copper tube. 使用於軟銅管

### MULTI SIZES TUBE BENDER



180° 3合1  
鋁合金彎管器

▶▶▶ **CH-367 3-IN-1 TUBE BENDER**

For 1/4", 5/16", 3/8" O.D. tubing with fixed hook, bends up to 180°.

▶▶▶ **CH-367M 3-IN-1 TUBE BENDER**

For 6mm, 8mm, 10mm O.D. tubing with fixed hook, bends up to 180°.



90° 3合1  
鋁合金彎管器

▶▶▶ **CH-368 3-IN-1 TUBE BENDER**

For 1/4", 5/16", 3/8" O.D. tubing 90° degree bent.

▶▶▶ **CH-368M 3-IN-1 TUBE BENDER**

For 6mm, 8mm, 10mm O.D. tubing 90° degree bent.



180° 4合1  
塑鋼纖維彎管器

▶▶▶ **CH-369 4-IN-1 TUBE BENDER**

For 3/16", 1/4", 5/16", 3/8" & 5mm, 6mm, 8mm, 10mm O.D. tubing 180° bent.



槓桿型彎管器

▶▶▶ **CH-364-04-1/4"**

▶▶▶ **CH-364A-6mm**

For 1/4" / 6mm O.D. tubing 180° degree bent.

▶▶▶ **CH-364-05-5/16"**

▶▶▶ **CH-364A-8mm**

For 5/16" / 8mm O.D. tubing 180° degree bent.



槓桿型彎管器

▶▶▶ **CH-364-06-3/8"**

▶▶▶ **CH-364A-10mm**

For 3/8" / 10mm O.D. tubing 180° degree bent.

▶▶▶ **CH-364-08-1/2"**

▶▶▶ **CH-364A-12mm**

For 1/2" / 12mm O.D. tubing 180° degree bent.



白鐵軟管彎管器

Only for copper, brass, aluminum and stainless steel tube which thickness is below 1 m/m and soft.

適合厚度1m/m以下

▶▶▶ **CH-366A-04-1/4"**

▶▶▶ **CH-366M-06mm**

For 1/4"/6MM O.D tubing. 9/16" radius to center of tube

▶▶▶ **CH-366A-05-5/16"**

▶▶▶ **CH-366M-08mm**

For 5/16"/8mm. O.D tubing. 11/16" radius to center of tube

▶▶▶ **CH-366A-06-3/8"**

▶▶▶ **CH-366M-10mm**

For 3/8"/10mm O.D tubing. 15/16" radius to center of tube

▶▶▶ **CH-366A-08-1/2"**

▶▶▶ **CH-366M-12mm**

For 1/2"/12mm O.D tubing. 1-1/2" radius to center of tube



槓桿型彎管器

▶▶▶ **CH-364-10-5/8"**

▶▶▶ **CH-364A-16mm**

For 5/8" / 16mm O.D. tubing 180° degree bent.

▶▶▶ **CH-364-12-3/4"**

▶▶▶ **CH-364A-19mm**

For 3/4" / 19mm O.D. tubing 180° degree bent.

▶▶▶ **CH-364-14-7/8"**

▶▶▶ **CH-364A-22mm**

For 7/8" / 22mm O.D. tubing 180° degree bent.



## 彎管器組

適用於軟管

### TUBE BENDER KIT



▶▶▶ **CH-364L**

Kit for bending 1/4", 5/16", 3/8", 1/2", 5/8" w/carrying box.

▶▶▶ **CH-364LM**

Kit for bending 6, 8, 10, 12, 16 mm w/carrying box.



## 經濟型彎管器

適用於軟管

### ECONOMICAL TYPE



組合示意圖

▶▶▶ **CH-365**

For 1/4", 3/8", 1/2", 5/8" O.D. tubing

\*\* 5/16" is optional \*\*

▶▶▶ **CH-365M**

For 8, 10, 12, 16 mm O.D. tubing

\*\* 6, 14, 15mm is optional \*\*





# 切管刀

## TUBE CUTTER



new

Rubber Handle 橡膠握把

軸承式切刀  
AXLE BEARING TYPE  
▶▶ CH-274ARB  
1/8"~1-1/8" O.D. tubing



Rubber Handle 橡膠握把

軸承式切刀  
AXLE BEARING TYPE  
▶▶ CH-312ARB  
1/4"~1-5/8" O.D. tubing



快速型切管刀

▶▶ CH-206A  
6~67mm / 1/4"~2-5/8"  
O.D. tubing



Rubber Handle 橡膠握把

▶▶ CH-274A  
1/8"~1-1/8" O.D. tubing



Rubber Handle 橡膠握把

▶▶ CH-312A  
1/4"~1-5/8" O.D. tubing



▶▶ CH-206  
Capacity : 3/8"~2-5/8" O.D. tubing  
Aluminum alloy body, chrome  
plated finish and sand with spare  
cutting blade.



▶▶ CH-274  
Capacity : 1/8"~1-1/8" O.D. tubing  
Aluminum alloy body, chrome  
plated finish and sand blast with a  
spare cutting blade.



▶▶ CH-312  
Capacity : 1/4"~1-5/8" O.D. tubing  
Aluminum alloy body, chrome  
plated finish and sand blast with a  
spare cutting blade.



▶▶ CH-104  
Capacity : 1/4"~1-1/4" O.D. tubing  
Aluminum alloy body, red color  
painted  
with a spare cutting blade.



▶▶ CH-105  
Capacity : 1/8"~1-3/8" O.D. tubing  
Aluminum alloy body, silver color  
painted with a spare cutting blade.



▶▶ CH-107  
Capacity : 1/4"~2" O.D. tubing  
Aluminum alloy body, silver color  
painted with a spare cutting blade.



▶▶ CH-2616  
3~16mm / 1/8"~5/8"  
O.D. tubing



▶▶ CH-2622  
6~22mm / 1/4"~7/8"  
O.D. tubing



▶▶ CH-127  
Capacity : 1/8"~5/8"  
O.D. tubing Zinc alloy  
body, zinc plated finish

new

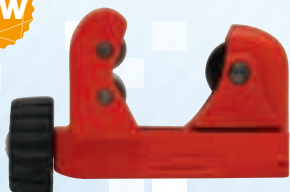

▶▶ CH-2629  
3-28mm / 1/8"~1-1/8"  
O.D. tubing

new



軸承式切刀

AXLE BEARING TYPE

▶▶ CH-2616RB  
3-16mm / 1/8"~5/8" O.D. tubing.  
▶▶ CH-2622RB  
6-22mm / 1/4"~7/8" O.D. tubing.  
▶▶ CH-2629RB  
3-28mm / 1/8"~1-1/8" O.D. tubing.



## 刀片組 CUTTING BLADE KIT

▶▶▶ **CH-235** Customize combination is available!!

NO.	ITEM	QTY	DESCRIPTION	O.D.	I.D.	THICKNESS
1	DT-100-BT	5	For DT-100, DT-100S			
2	CH-206B	2	For CH-206	18.78mm	5mm	6.25mm
3	CH-127B	5	For CH-127	15.22mm	4.8mm	3mm
4	CH-104B	5	For CH-104/107	18mm	4.8mm	3mm
5	CH-274B	5	For CH-274/312	17.5mm	4.7mm	6.18mm
6	CH-274A-TB	5	For CH-274A/312A/105	15.85mm	4.8mm	3.1mm
OPTIONAL	CH-2616-TB		For CH-2616/2622/2629	17.85mm	4.8mm	5.9mm
	CH-206A-TB		For CH-206A	18.4mm	4.7mm	5.9mm
	CH-312ARB-TB		For CH-274ARB/CH-312ARB	15.85mm	4.8mm (W/Axle bearing)	3.1mm



## HSS 刀片組 HSS BLADES KIT FOR TUBE CUTTER

可任意搭配尺寸

▶▶▶ **TCH-BTSET**

CH-104-TBHSS × 5PCS  
CH-274-TBHSS × 5PCS  
CH-274A-TBHSS × 5PCS



NO.	ITEM	DESCRIPTION	O.D.	I.D.	THICKNESS
1	CH-104-TBHSS	For CH-104 & 107	18mm	4.8mm	3mm
2	CH-274-TBHSS	For CH-274 & 312	17.5mm	4.7mm	6.18mm
3	CH-274A-TBHSS	For CH-274A/312A/105	15.85mm	4.8mm	3.1mm
4	CH-206A-TBHSS	For CH-206A/2616/2622/2629	18.4mm	4.7mm	5.9mm
5	CH-312ARB-TBHSS	For CH-274ARB/CH-312ARB	15.85mm	4.8mm (W/Axle bearing)	3.1mm

Customize combination is available!!  
Optional: single packing or 3-IN-1 packing.

## 塑膠硬管剪 PVC PIPE CUTTER

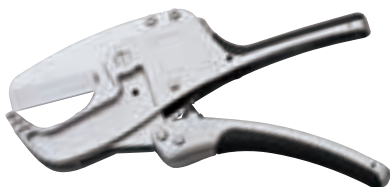

▶▶▶ **CH-KMS14**  
63mm pro PVC pipe cutter.  
Size enlarged & easy to maneuver.



▶▶▶ **CH-KMS17**  
38mm PVC pipe cutter.  
▶▶▶ **CH-KMS18**  
42mm PVC pipe cutter.



▶▶▶ **CH-KMS09**  
42mm pro PVC pipe cutter.  
▶▶▶ **CH-KMS10**  
63mm pro PVC pipe cutter.  
▶▶▶ **CH-KMS11**  
30mm pro PVC pipe cutter.



▶▶▶ **CH-42**  
Professional PVC cutter capacity up to 42mm.  
▶▶▶ **CH-35**  
Professional PVC cutter capacity up to 35mm.

## 切管刀 CUTTER



塑膠軟管剪  
▶▶▶ **CH-2166**  
26mm auto-open tubing cutter.

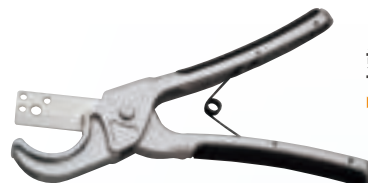

塑膠軟管剪  
▶▶▶ **CH-KMS15**  
38mm pro PVC pipe cutter.



毛細管剪刀  
CAPILLARY TUBE CUTTER  
▶▶▶ **CH-128L**  
Special steel forging capillary shape. Suitable for cutting wire and tube. The maximum diameter is 4mm.



毛細管剪刀  
CAPILLARY TUBE CUTTER  
▶▶▶ **CH-128**  
Cuts all sizes of capillary tubes without collapsing nor swaging the tubes.

# 毛邊刀 DEBURRING TOOL

SUJ2 BLADE



迷你型易攜帶 / 塑膠握把



可換刀片  
鋁料握把



固定式刀片  
鋁料握把

## DT-100S

- \*Small size
- \*Easy carry with 5 colors
- \*For inner of tube

## DT-100SC

- \*Small size
- \*Easy carry with 5 colors
- \*For lateral of tube, inner & outer of tube at one deburring

## DT-100SRA

- \*Small size
- \*Easy carry with 5 colors
- \*For small or corner of tube

## DT-200SET

- Blade replaceable
- Large & easy Hold
- Aluminum handle with shiny painting

## DT-300SET

- Pocket type with a clip
- Aluminum body

new



## DT-200-45

Blue color, for 1/4" ~ 5/8" O.D. tube.

## DT-200-4534

Blue color, for 1/4" ~ 3/4" O.D. tube.



## DT-200

Red color, For inner of tube



## DT-200C

Yellow color, For lateral of tube, inner & outer of tube at one deburring



## DT-200RA

Blue color, For small or corner of tube



## DT-300

Red color, For inner of tube



## DT-300C

Yellow color, For lateral of tube, inner & outer of tube at one deburring



## DT-300RA

Blue color, For small or corner of tube



塑膠握手可內裝刀片

## DT-100

- \*Plastic yellow handle
- \*With a spare blade
- \*For inner of tube



## DT-100RA

- \*Plastic Yellow Handle
- \*With a Spare Blade
- \*For small or corner of tube



## DT-100C

- \*Plastic yellow handle
- \*With a spare blade
- \*For lateral of tube, inner & outer of tube at one deburring



## DT-100CRA

- \*Plastic orange handle
- \*Blade replaceable w/3 kinds of blades

# 毛邊刀刀片組/錐形毛邊刀刀頭/氣電動毛邊刀頭

## BLADES KIT FOR DEBURRING TOOL



## DT-BTSET

- DT-100-BTSUJ2 ×5PC
- DT-200C-BT ×5PC
- DT-200RA-BT ×5PC

1	2	3
DT-100-BTSUJ2	DT-200C-BT	DT-200RA-BT
*General type blade	*C type blade	*RA type blade
*For inner of tube	*For lateral of tube, inner & outer of tube at one deburring	*For small or corner of tube

Optional: single packing or 3-IN-1 packing.

new



## DT-100-45BT

1/4" ~ 5/8" O.D. tube

## DT-100-45BT34

1/4" ~ 3/4" O.D. tube

## PNEUMATIC DEBURRING TOOL (HEAD ONLY)

new



適用電動起子

## DT-BT45118

for 1/4" ~ 1-1/8" O.D. tube

## DT-BT45138

for 1/4" ~ 1-3/8" O.D. tube

## 絞刀

### INNER-OUTER REAMER

REAMS BOTH INSIDE AND OUTSIDE EDGES OF TUBING



▶▶▶ **CH-208**  
Plastic body, (塑膠)  
3/16"~1-1/2" O.D.

▶▶▶ **CH-209**  
Zinc body, (鋅合金)  
1/4"~1-5/8" O.D.



▶▶▶ **CH-209A**  
Aluminum body, (鋁合金)  
SCM440 blade  
(紅十字材質安全刀片)  
3/8"~1-3/8" O.D.

▶▶▶ **CH-209AL** (大尺寸)  
Aluminum body, (鋁合金)  
SCM440 blade  
3/8"~2-1/8" O.D.

安全刀片

## 扭力扳手工具

### TORQUE WRENCH TOOL



#### 棘輪式扳手

▶▶▶ **CH-112**  
Ratchet wrench 1/2"DR.,  
length: 242mm.



#### 附膠把棘輪式扳手

▶▶▶ **CH-112P**  
Ratchet wrench 1/2"DR.,  
length: 250mm.



#### 單一尺寸扭力扳手

▶▶▶ **FIXED TORQUE**

ITEM NO.	DRIVER	RANGE	L mm	kg
CH-STW-H17	17mm	18 Nm	220	0.36
CH-STW-H22	22mm	42 Nm	230	0.39
CH-STW-H24	24mm	55 Nm	230	0.39
CH-STW-H26	26mm	55 Nm	290	0.52
CH-STW-H27	27mm	65 Nm	290	0.52
CH-STW-H29	29mm	65 Nm	295	0.53



#### 組合式扭力扳手

▶▶▶ **CH-STW-07**  
Sizes : 17, 22, 24, 26, 27, 29mm.  
\*\* 19, 25, 28, 32mm is optional \*\*



#### 組合式扭力扳手

▶▶▶ **CH-STW-80N8**  
Interchangeable torque wrench  
Kit 10-80 Nm  
1/2"Dr. ratchet head  
Open ended heads: 17, 22, 24,  
26, 27, 29mm and 1 pc ratchet  
head.



#### 套筒式扭力扳手

▶▶▶ **CH-210N11**  
1-1/2"DR Torque wrench kit 40-210 Nm  
w/6pcs 1/2" socket: 17, 19, 21, 22, 24 & 27 mm  
w/4pcs 1/2" hex socket bit: 6, 8, 10, 12 mm  
▶▶▶ **CH-150F11**  
1-1/2"DR Torque wrench kit 30-150 ft.lb  
w/6pcs 1/2" socket: 17, 19, 21, 22, 24 & 27 mm  
w/4pcs 1/2" hex socket bit: 6, 8, 10, 12 mm



#### 組合式扭力扳手

▶▶▶ **CH-STW-04**  
4 Sizes: 17.22.26.29mm  
▶▶▶ **CH-STW-06**  
6 Sizes: 17.22.24.26.27.29mm



## 離合器拆卸工具組

### CLUTCH REMOVE INSTALL TOOL



▶▶▶ **CH-249**  
For SD, GM, ford, chrysler  
complete kit in a blow plastic case.

## 壓縮機工具組

### A/C COMPRESSOR CLUTCH REMOVER KIT



▶▶▶ **CH-248**  
Replace clutches  
found on Fs6,  
C171, 6P & 148  
computer.  
Also GM R4 & A6,  
HR-6, DA-6 & V5 A  
/ C compressors.  
And compressors of  
sanden Sd505,  
507, 508, 510,  
575, 708 and 709.  
2 & 3 hole puller  
plate fits most  
clutches, the  
mechanical force  
does the pulling  
job.

## 萬用離合器工具

### UNIVERSAL A/C CLUTCH HOLDING TOOL



▶▶▶ **CH-N001T**  
Hold compressor clutch plate for  
retaining nut remove & installation.



## 彈簧彎管器 SPRING BENDER

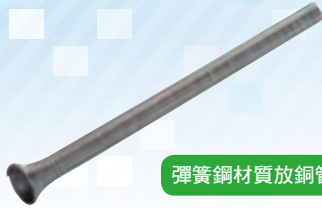

彈簧鋼材質放銅管外

- ▶▶▶ CH-102-04  
Size 1/4" length 10"
- ▶▶▶ CH-102-05  
Size 5/16" length 10"
- ▶▶▶ CH-102-06  
Size 3/8" length 10"
- ▶▶▶ CH-102-08  
Size 1/2" length 12"

- ▶▶▶ CH-102-10  
Size 5/8" length 14"
- ▶▶▶ CH-102-12  
Size 3/4" length 14"
- ▶▶▶ CH-102-14  
Size 7/8" length 14"

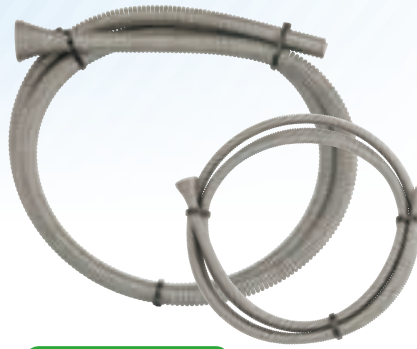

白鐵材質放置銅管內

- ▶▶▶ CH-202-06IN150  
Size 3/8" length 150cm
- ▶▶▶ CH-202-08IN150  
Size 1/2" length 150cm
- ▶▶▶ CH-202-10IN150  
Size 5/8" length 150cm
- ▶▶▶ CH-202-12IN150  
Size 3/4" length 150cm
- ▶▶▶ CH-202-06IN250  
Size 3/8" length 250cm
- ▶▶▶ CH-202-08IN250  
Size 1/2" length 250cm
- ▶▶▶ CH-202-10IN250  
Size 5/8" length 250cm
- ▶▶▶ CH-202-12IN250  
Size 3/4" length 250cm

\*\* Customized length \*\*  
\*\* 304 Stainless steel; inside copper tube usage \*\*  
\*\* 可依客戶須求特製長度 \*\*

## 沖仔組 SWAGING PUNCH



- ▶▶▶ CH-95  
5-in-1 punch  
Swaging punch  
for 1/4", 5/16", 3/8",  
1/2" & 5/8" O.D.



- ▶▶▶ CH-95M  
5-IN-1  
For 8, 10, 12,  
14, 16mm O.D.

- ▶▶▶ CH-94  
3-IN-1  
For: 1/2", 5/8",  
And 7/8" O.D.

- ▶▶▶ CH-96  
3-IN-1  
For: 5/8", 7/8",  
And 1-1/8"  
O.D.



- ▶▶▶ CH-193  
Swaging punch for  
1/4", 5/16", 3/8", 1/2" &  
5/8" O.D. tubing.
- ▶▶▶ CH-93-03 (3/16")
- ▶▶▶ CH-93-04 (1/4")
- ▶▶▶ CH-93-05 (5/16")
- ▶▶▶ CH-93-06 (3/8")
- ▶▶▶ CH-93-08 (1/2")
- ▶▶▶ CH-93-10 (5/8")
- ▶▶▶ CH-93-12 (3/4")

## 手工具系列 SERVICE TOOL



- 散熱刷
- ▶▶▶ CH-352  
FIN STRAIGHTENER  
Fin straightener stainless  
steel, can clean & straighten  
evaporator fin.

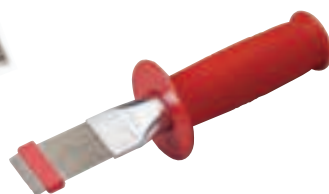

- 散熱刷
- ▶▶▶ CH-352L  
Fin straightener with  
PVC handle.



- 散熱刷
- ▶▶▶ CH-351  
FIN STRAIGHTENER  
Fin straightener 8,9,10,12,14,15  
spacing per inch.  
can make with green handle if  
require.



- 電纜線皮刀
- ▶▶▶ CH-65  
CABLE CUTTER  
Blade: 65mm

## 扳手工具組 HIGH QUALITY HEX/TORX WRENCH

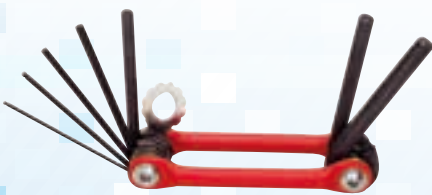

- CRV-6150 double foldout / HEX type
- ▶▶▶ CH-HM Red color handle  
Size: 1.5, 2, 2.5, 3, 4, 5, 6mm
- \*\* ⊕SL or ⊕PH type / NI material is available \*\*

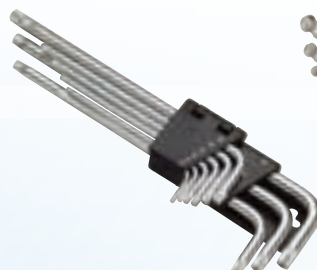

- CRV-6150 cover, TORX type
- ▶▶▶ CH-TW-NI Ni plated  
Size: T10, T15, T20, T25, T27, T30, T40, T45, T50
- \*\* Other color painted / S2, 8860 material is also available \*\*

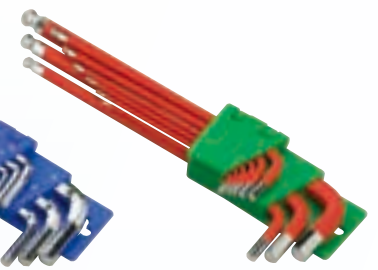
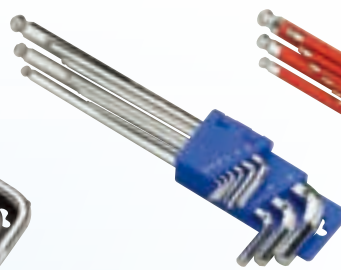

- CRV 6150 cover HEX type
- ▶▶▶ CH-HW-NI Ni plated
  - ▶▶▶ CH-HW-R Red color painted
  - ▶▶▶ CH-HW-B Blue color painted  
Size: 1.5, 2, 2.5, 3, 4, 5, 6, 8, 10 mm

## 棘輪扳手工具

### OPENING SINGAL ENDED RATCHET WRENCH



▶▶▶ **CH-122**  
4 size : 1/4", 3/8", 3/16",  
5/16" Square ratchet.



弧型棘輪式  
▶▶▶ **CH-122L**  
4 size : 1/4", 3/8", 3/16", 5/16"  
Square ratchet with curve  
shape handle.



▶▶▶ **CH-123**  
4 size : 1/4", 3/16", square  
9/16", 1/2" hex ratchet.

#### 弧型棘輪式

▶▶▶ **CH-123L**  
4 size : 1/4" 3/16", square  
9/16", 1/2" hex ratchet.  
with curve shape handle.



圓管扳手  
▶▶▶ **CH-210A**  
Can be used on pneumatic & hydraulic  
connections such as brake pipes.  
SIZE: 10, 11, 13, 17, 19, 22 mm.  
\*\* 12,14 mm is optional \*\*  
\*\* 24,27,30,32 mm Individual sells only \*\*



▶▶▶ **CH-916**  
SIZE: 9/16"  
\*\* 13,14 mm is optional \*\*

## 鐵片剪刀

### AVIATION/OFFSET SNIP

- Material: CRM-63 steel blades
- Blade: Black phosphate finish resists rust
- Hardness: 58-63HRC
- Packing: sliding card packed
- Maximum 1.2mm thickness



▶▶▶ **CH-RC1**  
Left-cut, red handle



▶▶▶ **CH-RC2**  
Right-cut, green handle



▶▶▶ **CH-RC3**  
Straight-cut, yellow handle



▶▶▶ **CH-RC4**  
Offset snip, laborsaving cutting  
Solid and comfortable handle  
with non-slip design

## 圓管 C 型夾

### COCKING "C"



▶▶▶ **CH-RC5**  
Locking "c" round clamp  
Multipurpose 48mm~100mm

## 鐵板夾鉗

### CLAMP



▶▶▶ **CH-306**  
Locking "c" clamps  
Size: 6", 11", 18"

## 鎖鏈夾

### LOCKING CHAIN CLAMP



▶▶▶ **CH-316**  
SIZE: 19" chain

## 鉗子

### LOCKING PLIERS



冷媒回收鉗  
▶▶▶ **CH-308**  
Refrigerant recovery tool  
INSTA-TAP.8"



萬能鉗  
▶▶▶ **CH-305**  
Curved jaws size: 5", 7", 10"  
Drop forged steel jaws  
CR-V steel jaws



封口鉗  
▶▶▶ **CH-201 PINCH OFF PLIER**  
Pinch off plier 7" can pinch  
off copper tubing instantly.

## UV 探測工具 UV INSPECTION KIT

new



補漏劑

**EXTREME ULTRA**

▶▶▶ **TR1163.AL.J9**

EXTREME ULTRA is an ultimate Refrigerant Gas Leak Stop that solves all the problems related to small refrigerant gas leakages in vehicle A/C systems.

EXTREME ULTRA locates the refrigerant gas leaks and permanently seals them, without reacting to moisture and oxygen. EXTREME ULTRA is a polymer-free solution that repairs leaks up to 0.3 mm.

Optional for 6ml only.

## 接管工具

### SPRING LOCK COUPLING TOOL

new



冷媒螢光劑

**Brilliant UV LEAK DETECTOR DYE**

▶▶▶ **TR1068.A12.J9**

BRILLIANT HVAC&R is a fluorescent UV Leak Detector Dye that provides safe, fast and precise detection of small Refrigerant Gas leaks from A/C Refrigeration Systems and vehicle A/C system.

12 Cartridges of 7.5ml, MOQ: 1 Carton (=20Cartridges)



▶▶▶ **T-R-16253**

\*適用於車用冷氣系統

R134a Leak detection dye robinair tracker, for use with all PAG oil refrigerant systems, including R134a (7.39ml/bottle, 12 bottles/ small box)



▶▶▶ **CH-035**

\*\*Waterproof

\*\*Super bright SUV-LEDs

\*\*Auto locked ON/OFF

\*\*Safety goggle included

\*\*Operated with 3xAA battery

\*\*Complete kit in a blow case



▶▶▶ **CH-T068**

Spring lock coupling tool FOR 3/8", 1/2", 5/8", 3/4" 4 Color per set



▶▶▶ **CH-SL7**

Fuel line disconnect tool set SIZE: 1/4", 5/16", 3/8", 1/2", 5/8", 3/4", 7/8"

## 閥蕊裝拆工具 CORE TOOL



▶▶▶ **CH-1213**

Steel material body



▶▶▶ **CH-1213AL**

Aluminum material body Steel material tube easy carry with 4PCS.



▶▶▶ **CH-1213B**

Bronze body Steel material tube.



▶▶▶ **CH-1213CV**

Steel material, W/ 4\*PCS of CH-9520C valve core

\*\* valve core are optional \*\*



▶▶▶ **CH-1213P**

Plastic handle steel material tube. Blister packed for green\*1 & red\*1

## 測漏注射工具 OIL/UV LEAK DETECTION INJECTOR

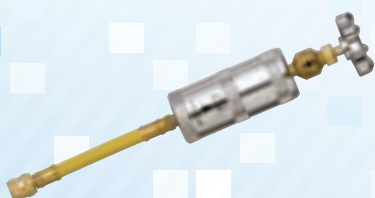

▶▶▶ **CH-345**

1/4" F.F. x 1/4" M.F.

▶▶▶ **CH-346**

1/2" F. ACME HOSE x 1/2" M. ACME



▶▶▶ **CH-347**

1/4" M.F. W/shut-off ball valve QC-12L Quick connect style



## 閥蕊移除 / 安裝工具

### VALVE CORE REMOVER / INSTALLER



▶▶ CH-19BV 1/4"

W/1/4" M.F x 5/16" F.F adapter



▶▶ CH-19BV-CV 1/4"

W/1/4" M.F x 5/16" F.F adapter  
charging valve

## 閥蕊移除 / 安裝工具修理包組

### VALVE CORE INSTALLER/REMOVER KIT

▶▶ CH-19BVKIT



NO.	ITEM	Q'ty	Description
1	CH-19BV w/ adapter	1	Valve core remover/installer w/1/4" M.F. x 5/16" F.F. adapter
2	CH-9520C	10	Valve core
3	0GB79583P1	10	1/4" SAE Depressor
4	0R501-3	20	1/4" SAE Hose gasket
5	0R9134-4	20	5/16" SAE Hose gasket

## 球閥開關接頭組

### SHUT - OFF BALL VALVE FITTING / ADAPTER

#### CH-16BV-SET

Item No.	Description
1. CA-05 x 04 CV	5/16"F. SAE x 1/4"M. SAE w/valve core
2. CA-04 x 05 CV	1/4"F. SAE x 5/16"M. SAE w/valve core
3. CH-16BV - 04 x 05	1/4"M. SAE x 5/16" SAE 45° solder
4. CH-16BV - 08 x 05	1/2"M. ACME x 5/16" SAE 45° solder
5. CH-16BV - 06 x 05	3/8"M. SAE x 5/16" SAE 45° solder
6. CH-16BV - L x 05	Quick coupler low side x 5/16" SAE. 45° solder
7. CH-16BV - H x 05	Quick coupler high side x 5/16" SAE. 45° solder

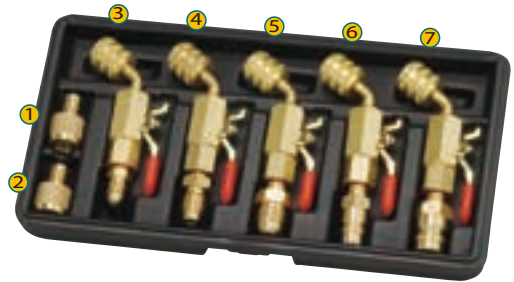

#### CH-17BV-SET

Item No.	Description
1. CA-05 x 04 CV	5/16"F. SAE x 1/4"M. SAE w/valve core
2. CA-04 x 05 CV	1/4"F. SAE x 5/16"M. SAE w/valve core
3. CH-17BV - 05 x 04	5/16"M. SAE x 1/4" SAE 45° solder
4. CH-17BV - 08 x 04	1/2"M. ACME x 1/4" SAE 45° solder
5. CH-17BV - 06 x 04	3/8"M. SAE x 1/4" SAE 45° solder
6. CH-17BV - L x 04	Quick coupler low side x 1/4" SAE. 45° solder
7. CH-17BV - H x 04	Quick coupler high side x 1/4" SAE. 45° solder



#### CH-18BV-SET

Item No.	Description
1. CA-05 x 04 CV	5/16"F. SAE x 1/4"M. SAE w/valve core
2. CA-04 x 05 CV	1/4"F. SAE x 5/16"M. SAE w/valve core
3. CH-18BV - 04 x 08	1/4"M. SAE x 1/2".F. ACME 45° solder
4. CH-18BV - 05 x 08	5/16"M. SAE x 1/2" .F. ACME 45° solder
5. CH-18BV - 06 x 08	3/8"M. SAE x 1/2" .F. ACME 45° solder
6. CH-18BV - L x 08	Quick coupler low side x 1/2" ACME. 45° solder
7. CH-18BV - H x 08	Quick coupler high side x 1/2" ACME. 45° solder



## 球閥開關

### SHUT-OFF VALVE FOR ANY TYPE OF FREON

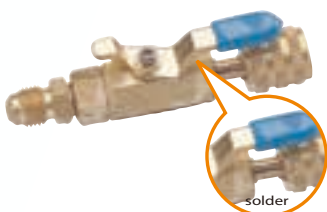

▶▶ CH-15BV-SH

1/4" male x 1/4" female

▶▶ CH-15BV-IT

5/16" male x 5/16" female

\*\* CH-15BV-SH & CH-15BV-IT has red/yellow/blue rubber cap.\*\*



▶▶ CH-15BV-SHA

1/4" male x 1/4" male

▶▶ CH-15BV-ITA

5/16" male x 5/16" male

\*\* CH-15BV-SHA & CH-15BV-ITA has red/yellow/blue rubber cap.\*\*

# 中小型車用墊圈修理組 / 修理包組

## HOSE-SEAL, GASKET & CORE KIT

### ▶▶ D005

O-RING KIT(TOTAL 265PCS)

\*\* For general small car & middle truck \*\*

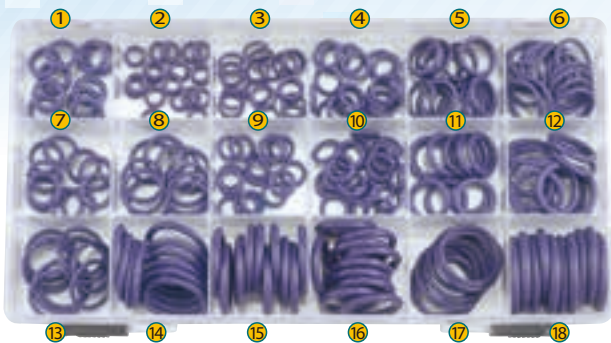

1 7.6 x 2.4 mm Expansion valve 20pcs	2 4.47 x 1.78mm Expansion valve 20pcs	3 5/16" 20pcs	4 3/8" 20pcs	5 1/2" 20pcs	6 5/8" 20pcs
7 3A universal 20pcs	8 5A universal 10pcs	9 7/16" 15pcs	10 3 20pcs 6.8 x 1.9mm	11 4 10pcs 10.8 x 2.4mm	12 5 10pcs 13.8 x 2.4mm
13 3/4" 10pcs	14 6 10pcs 18.72 x 2.62mm	15 General H 10pcs	16 General L 10pcs	17 PEUGEOT VOLKSWAGEN 10pcs	18 HYUNDAI FORD GM CITROEN MITSUBISHI 10pcs

### ▶▶ D004

HNBR O-RING kit 8 sizes  
240 pcs metric units



1 6.07 x 1.78 40PCS	2 8.8 x 1.9 40PCS	3 10.6 x 2.4 30PCS	4 10.9 x 1.9 30PCS
5 13.7 x 1.9 30PCS	6 15 x 1.8 30PCS	7 13.8 x 2.5 20PCS	8 17 x 2.5 20PCS



### ▶▶ CH-79583-PT

Hose seal teflon gasket, 3pcs 1/4" SAE teflon gasket and 1pc brass depressor.

Teflon size:8.1x4.6x7.5mm

### ▶▶ CH-79583-PTN

Hose seal teflon gasket, 3pcs 1/4" SAE teflon gasket and 1pc brass depressor.

Teflon size:7.7x4.9x7.4mm



### ▶▶ CH-79583

Hose seal gasket, 3pcs gaskets and 1pc thread brass depressor.

### ▶▶ CH-79586

Hose seal gasket, 6pcs gaskets and 1pc thread brass depressor.



### ▶▶ CH-79583-P1

Hose seal gasket, 3pcs gaskets and 1pc thread brass depressor.



### ▶▶ AS-GK04 1/4"

2pcs o-ring (one is 1/4"), 1pc spacer, 1pc thread brass depressor, 1pc spring and 1pc clamp ring.

### ▶▶ AS-GK05 5/16"

2pcs o-ring (one is 5/16"), 1pc spacer, 1pc thread brass depressor, 1pc spring and 1pc clamp ring.

### ▶▶ CH-238



NO.	ITEM	QTY	DESCRIPTION
1	ORQCL-3	10	for QC-L
2	ORQCH-3	10	for QC-H
3	ORQC-3	10	for QC-12L
4	ORQC-4	10	for QC-12H
5	OR340-2	10	for CH-340
6	OR146	10	for CH-146 CA-04 x 06 CA-04 x 08
7	ORVCR	10	for VCR-04
8	OR501-3	15	for R12 1/4" SAE Hose gasket
9	OR9134-4	10	for R410 5/16" SAE Hose gasket
10	OR501-3H	15	for R134. R410 1/4" SAE Hose gasket

## 萬用管路 / 測漏接頭組

### A/C UNIVERSAL PIPELINE CLEANING AND LEAK CONNECTOR

#### ▶▶ CH-AD-SET





## 閥蕊拆裝修理包組 HOSE-SEAL, GASKET & CORE KIT

### ▶▶▶ CH-236



NO.	ITEM	QTY	DESCRIPTION
1	CH-9520C	10	Valve cores
2	CH-9800	10	R134 Valve cores
3	CH-L08	5	8mm Low side
4	CH-V066	5	For Peugeot / Volvo
5	CH-H10	5	10mm High side
6	CH-GMH	5	for GM high
	CH-1213P	1	Valve core remover

### ▶▶▶ CH-237



NO.	ITEM	QTY	DESCRIPTION
1	CH-1213AL	1	Valve core remover
2	CH-9520C	10	Valve cores
3	CH-9800	10	R134 Valve core
4	OR9134-4	10	R410 5/16" SAE hose gasket
5	OR501-3	30	R12 1/4" SAE hose gasket
6	OGB79583	10	1/4" SAE depressor

### ▶▶▶ CH-239

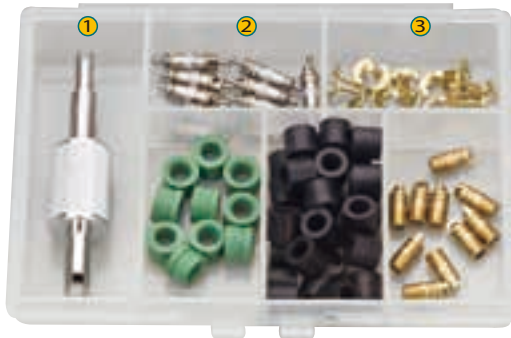

NO.	ITEM	QTY	DESCRIPTION
1	CH-1213AL	1	Valve core remover
2	CH-9520C	10	Valve cores
3	OGB79583P1	10	1/4" SAE depressor
4	OR9134-4	10	R410 5/16" SAE hose gasket
5	OR501-3	30	R12 1/4" SAE hose gasket
6	OGB79583	10	1/4" SAE depressor

## 車用/墊片&蓋子組 HOSE-SEAL, GASKET & CORE KIT

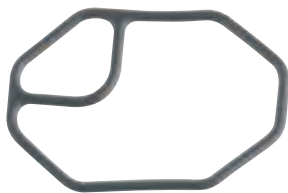

▶▶▶ **OR386**  
Gasket-for ND  
10PA15C, 10PA17C

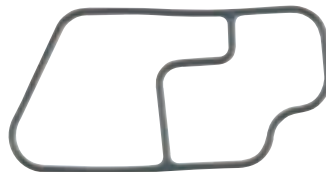

▶▶▶ **ORTS**  
Gasket for ALTIS & (NEW)  
SAAB 93.95 CAMRY-2400c.  
c.&2500c.c.2007



▶▶▶ **ORBENZ**  
Gasket-for BENZ

### ▶▶▶ CH-CP58 CAP KIT

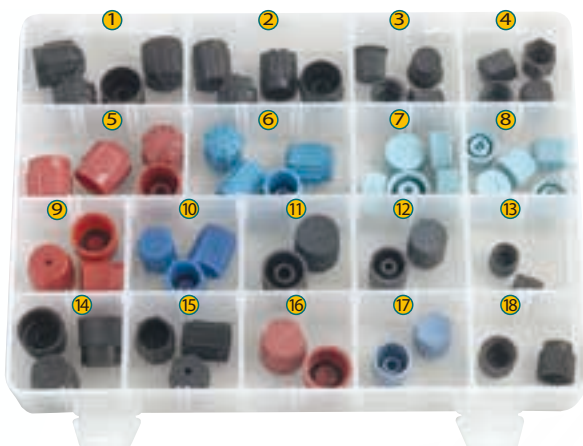

1	2	3	4
M10xP1 black (CH-CP01) 4pcs	M8XP1 black (CH-CP02) 4pcs	1/4" black (CH-CP03) 4pcs	1/4" black (CH-CP04) 4pcs
5	6	7	8
M10xP1 red (CH-CP05) 4pcs	M8XP1 blue (CH-CP06) 4pcs	M10xP1.25 blue high side (CH-CP07) 5pcs	M9xP1 blue low side (CH-CP08) 5pcs
9	10	11	12
8Tx17F red high side (CH-CP09) 3pcs	8Tx15F blue low side (CH-CP10) 3pcs	M10xP0.75 black (CH-CP11) 2pcs	M8xP1 black (CH-CP12) 2pcs
14	15	16	17
M10xP1 black high side (CH-CP14) 3pcs	M8xP1 black low side (CH-CP15) 3pcs	10Tx17F red high side (CH-CP16) 2pcs	M9xP1 blue (CH-CP17) 2pcs
			18
			1/2" ACME black (CH-CP18) 2pcs



# 快速接頭

## QUICK COUPLER FOR R12 & R134A & R410 & HFO-1234YF



- ▶▶▶ **QC-BV-1**  
R134a High pressure quick coupler w/cylinder adapter CA-04 x 08 1/4" M.F. x M14 x 1.5 w/O-RIGN
- ▶▶▶ **QC-BVM**  
1/4" M.F. w/o adapter

CA-04x08



- ▶▶▶ **QC-L1234**  
HFO-1234yf Low pressure, 12mm female, w/o adapter
- ▶▶▶ **QC-L1234-1**  
w/ adapter to switch to 1/4" M.F.

CA-04x12MM



- ▶▶▶ **QC-H1234**  
HFO-1234yf High pressure, 12mm female, w/o adapter
- ▶▶▶ **QC-H1234-1**  
w/ adapter to switch to 1/4" M.F.

CA-04x12MM



- ▶▶▶ **QC-LMS**  
Low pressure quick coupler fitted with 1/4" SAE connetion for small car
- ▶▶▶ **QC-LMS10**  
Low pressure quick coupler fitted with 10mm x 1.5 thread for small car



- ▶▶▶ **QC-LS**  
Low pressure quick coupler fitted with 14mm female thread for small car
- ▶▶▶ **QC-LS-1**  
Low pressure quick coupler fitted with 14mm female thread for small car W/CA-04 x 08 1pc



- ▶▶▶ **QC-HMS**  
High pressure quick coupler fitted with 1/4" SAE connetion for small car
- ▶▶▶ **QC-HMS12**  
High pressure quick coupler fitted with 12mm x 1.75 thread for small car



- ▶▶▶ **QC-HS**  
High pressure quick coupler fitted with 14mm female thread for small car
- ▶▶▶ **QC-HS-1**  
High pressure quick coupler fitted with 14mm female thread for small car W/CA-04 x 08 1pc



- ▶▶▶ **QC-LM**  
Low pressure quick coupler fitted with 1/4" SAE connetion
- ▶▶▶ **QC-LM10**  
Low pressure quick coupler fitted with 10mm x 1.5 thread



- ▶▶▶ **QC-L**  
Low pressure quick coupler fitted with 14mm female thread
- ▶▶▶ **QC-L-1**  
Low pressure quick coupler fitted with 14mm female thread W/CA-04 x 08 1pc



- ▶▶▶ **QC-HM**  
High pressure quick coupler fitted with 1/4" SAE connetion
- ▶▶▶ **QC-HM12**  
High pressure quick coupler fitted with 12mm x 1.75 thread



- ▶▶▶ **QC-H**  
High pressure quick coupler fitted with 14mm female thread
- ▶▶▶ **QC-H-1**  
High pressure quick coupler fitted with 14mm female thread W/CA-04 x 08 1pc



- ▶▶▶ **QC-12**  
High pressure & low pressure quick couplers fitted with 1/4" male flare hose thread.



- ▶▶▶ **QC-13**  
High pressure & low pressure quick couplers fitted with 10mm x1.5/ 12mm x1.75



- ▶▶▶ **QC-15**  
High pressure & low pressure quick couplers 90° fitted with 1/4" male thread. Specially suitable for small charging space or any angle charging.



- ▶▶▶ **QC-16**  
High pressure & low pressure quick couplers 90° fitted with 14mm female thread. Specially suitable for small charging space or any angle charging.



### 冷媒控制閥

- ▶▶▶ **CH-343-04 1/4"**  
1/4" M.F. x 1/4" F.F.
- ▶▶▶ **CH-343-04x05**  
1/4" M.F. x 5/16" F.F.

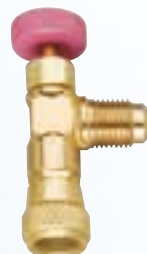

### 冷媒控制閥

- ▶▶▶ **CH-343-05 5/16"**  
5/16" M.F. x 5/16" F.F.
- ▶▶▶ **CH-343-05x04**  
5/16" M.F. x 1/4" F.F.

# 自動開關閥接頭

## AUTO SHUT-OFF VALVE ADAPTER / ADAPTER SET



### 直型自動開關閥接頭

#### STRAIGHT TYPE ADAPTER

Item No.	Description
AS-04x04	1/4"M.F.x1/4"F.F. (7/16"- 20UNF)
AS-04x05	1/4"M.F. (7/16"- 20UNF)x5/16"F.F. (1/2"- 20UNF)
AS-04x08ACME	1/4"M.F. (7/16"- 20UNF)x1/2"ACME F.F.
AS-05x04	5/16"M.F. (1/2"- 20UNF)x1/4"F.F. (7/16"- 20UNF)
AS-05x05	5/16"M.F.x5/16"F.F. (1/2"- 20UNF)
AS-08ACMEx04	1/2"ACME M.F.x1/4"F.F. (7/16"- 20UNF)
AS-08ACMEx08ACME	1/2"ACME M.F.x1/2"ACME F.F.

### L 型自動開關閥接頭

#### L TYPE ADAPTER

Item No.	Description
AS-04x04L	1/4"M.F. x1/4"F.F. 90° (7/16"- 20UNF)
AS-04x05L	1/4"M.F. (7/16"- 20UNF)x5/16"F.F. 90° (1/2"- 20UNF)
AS-04x08ACMEL	1/4"M.F. (7/16"- 20UNF)x1/2"ACME F.F. 90°
AS-05x04L	5/16"M.F. (1/2"- 20UNF)x1/4"F.F. 90° (7/16"- 20UNF)
AS-05x05L	5/16"M.F. x5/16"F.F. 90° (1/2"- 20UNF)
AS-08ACMEx04L	1/2"ACME M.F.x1/4"F.F. 90° (7/16"- 20UNF)



示意圖為AS004

AS001	1	2	3	4
	AS-04x04L 1/4"M.F.x1/4"F.F.90°	AS-05x05L 5/16"M.F.x5/16"F.F.90°	AS-04x04 1/4"M.F.x1/4"F.F.	AS-05x05 5/16"M.F.x5/16"F.F.
	AS-04x04L 1/4"M.F.x1/4"F.F.90°	AS-05x05L 5/16"M.F.x5/16"F.F.90°	AS-04x04 1/4"M.F.x1/4"F.F.	AS-05x05 5/16"M.F.x5/16"F.F.
AS002	1	2	3	4
	AS-04x04L 1/4"M.F.x1/4"F.F.90°	AS-05x05L 5/16"M.F.x5/16"F.F.90°	AS-04x05L 1/4"M.F.x5/16"F.F.90°	AS-05x04L 5/16"M.F.x1/4"F.F.90°
	AS-04x04L 1/4"M.F.x1/4"F.F.90°	AS-05x05L 5/16"M.F.x5/16"F.F.90°	AS-04x05L 1/4"M.F.x5/16"F.F.90°	AS-05x04L 5/16"M.F.x1/4"F.F.90°
AS003	1	2	3	4
	AS-04x05L 1/4"M.F.x5/16"F.F.90°	AS-05x04L 5/16"M.F.x1/4"F.F.90°	AS-04x05 1/4"M.F.x5/16"F.F.	AS-05x04 5/16"M.F.x1/4"F.F.
	AS-04x05L 1/4"M.F.x5/16"F.F.90°	AS-05x04L 5/16"M.F.x1/4"F.F.90°	AS-04x05 1/4"M.F.x5/16"F.F.	AS-05x04 5/16"M.F.x1/4"F.F.
AS004	1	2	3	4
	AS-08ACMEx04 1/2"ACME M.F.x1/4"F.F.	AS-08ACMEx08ACME 1/2"ACME M.F.x1/2"ACME F.F.	AS-04x04 1/4"M.F.x1/4"F.F.	AS-05x05 5/16"M.F.x5/16"F.F.
	AS-08ACMEx04 1/2"ACME M.F.x1/4"F.F.	AS-08ACMEx08ACME 1/2"ACME M.F.x1/2"ACME F.F.	AS-04x04 1/4"M.F.x1/4"F.F.	AS-05x05 5/16"M.F.x5/16"F.F.
AS005	1	2	3	4
	AS-08ACMEx04 1/2"ACME M.F.x1/4"F.F.	AS-08ACMEx08ACME 1/2"ACME M.F.x1/2"ACME F.F.	AS-08ACMEx04L 1/2"ACME M.F.x1/4"F.F.90°	AS-04x08ACME 1/4"M.F.x1/2"ACME
	AS-08ACMEx04 1/2"ACME M.F.x1/4"F.F.	AS-08ACMEx08ACME 1/2"ACME M.F.x1/2"ACME F.F.	AS-08ACMEx04L 1/2"ACME M.F.x1/4"F.F.90°	AS-04x08ACME 1/4"M.F.x1/2"ACME

# 自動開關閥冷媒管

## HOSE & AUTO SHUT-OFF VALVE FOR 22/134/410A/R32/HFO-1234YF

- CONNECTION THREAD CAN BE 1/4" SAE, 5/16" SAE OR 1/2" ACME.
- SPECIAL LENGTH OR INDIVIDUAL CHARGING HOSE IS AVAILABLE.



### HOSE W/AUTO SHUT-OFF VALVE

ITEM	LENGTH	CONNECTION THREAD	REFRIGERANT
CH-336RYB-SAS18 CH-360RYB-SAS18 CH-372RYB-SAS18 CH-396RYB-SAS18	3PCS×36" 3PCS×60" 3PCS×72" 3PCS×96"	1/4"×1/4" SAE-180'	R134A
CH-336RYB-S410AS18 CH-360RYB-S410AS18 CH-372RYB-S410AS18 CH-396RYB-S410AS18	3PCS×36" 3PCS×60" 3PCS×72" 3PCS×96"	1/4"×1/4" SAE-180'	R410
CH-336RYB-410AS18 CH-360RYB-410AS18 CH-372RYB-410AS18 CH-396RYB-410AS18	3PCS×36" 3PCS×60" 3PCS×72" 3PCS×96"	1/4"×5/16" SAE-180'	R410
CH-336RYB-S410-AAS18 CH-360RYB-S410-AAS18 CH-372RYB-S410-AAS18 CH-396RYB-S410-AAS18	3PCS×36" 3PCS×60" 3PCS×72" 3PCS×96"	5/16"×5/16" SAE-180'	R410
CH-336RYB-41005AS18 CH-360RYB-41005AS18 CH-372RYB-41005AS18 CH-396RYB-41005AS18	3PCS×36" 3PCS×60" 3PCS×72" 3PCS×96"	R.B:1/4"×5/16" SAE-180' Y:1/4"×1/4"-180'	R410

### HOSE W/AUTO SHUT-OFF VALVE

ITEM	LENGTH	CONNECTION THREAD	REFRIGERANT
CH-336RYB-MAS45 CH-360RYB-MAS45 CH-372RYB-MAS45 CH-396RYB-MAS45	3PCS×36" 3PCS×60" 3PCS×72" 3PCS×96"	R.Y.B.: 1/2"ACME- 180'x1/2"ACME-45'	R134A
CH-336RYB-MASL CH-360RYB-MASL CH-372RYB-MASL CH-396RYB-MASL	3PCS×36" 3PCS×60" 3PCS×72" 3PCS×96"	R.Y.B.: 1/2"ACME- 180'x1/2"ACME-90'	R134A
CH-336RYB-MAS18 CH-360RYB-MAS18 CH-372RYB-MAS18 CH-396RYB-MAS18	3PCS×36" 3PCS×60" 3PCS×72" 3PCS×96"	R.Y.B.: 1/2"ACME- 180'x1/2"ACME-180'	R134A

new

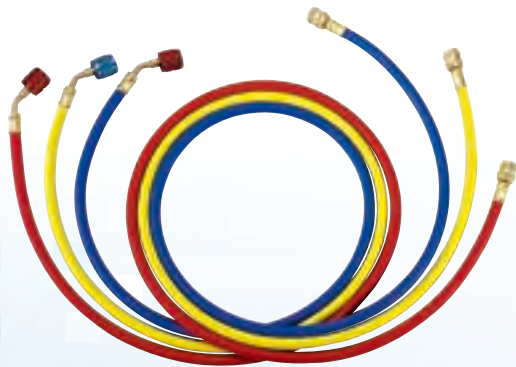

### HOSE W/AUTO SHUT-OFF VALVE

ITEM	LENGTH	CONNECTION THREAD	REFRIGERANT
CH-336RYB-SAS CH-360RYB-SAS CH-372RYB-SAS CH-396RYB-SAS	3PCS×36" 3PCS×60" 3PCS×72" 3PCS×96"	1/4"-180'×1/4"-45' SAE	R134A
CH-336RYB-S410AS CH-360RYB-S410AS CH-372RYB-S410AS CH-396RYB-S410AS	3PCS×36" 3PCS×60" 3PCS×72" 3PCS×96"	1/4"-180'×1/4"-45' SAE	R410
CH-336RYB-410AS CH-360RYB-410AS CH-372RYB-410AS CH-396RYB-410AS	3PCS×36" 3PCS×60" 3PCS×72" 3PCS×96"	1/4"-180'×5/16"-45' SAE	R410
CH-336RYB-S410-AAS CH-360RYB-S410-AAS CH-372RYB-S410-AAS CH-396RYB-S410-AAS	3PCS×36" 3PCS×60" 3PCS×72" 3PCS×96"	5/16"-180'×5/16"-45' SAE	R410
CH-336RYB-41005AS CH-360RYB-41005AS CH-372RYB-41005AS CH-396RYB-41005AS	3PCS×36" 3PCS×60" 3PCS×72" 3PCS×96"	R.B:1/4"-180'× 5/16"-45' SAE Y:1/4"-180'×1/4"-45'	R410



## 自動開關冷媒管

### HOSE & AUTO SHUT-OFF VALVE FOR 22/134/410A/R32/HFO-1234YF

- CONNECTION THREAD CAN BE 1/4" SAE, 5/16" SAE OR 1/2" ACME.
- SPECIAL LENGTH OR INDIVIDUAL CHARGING HOSE IS AVAILABLE.

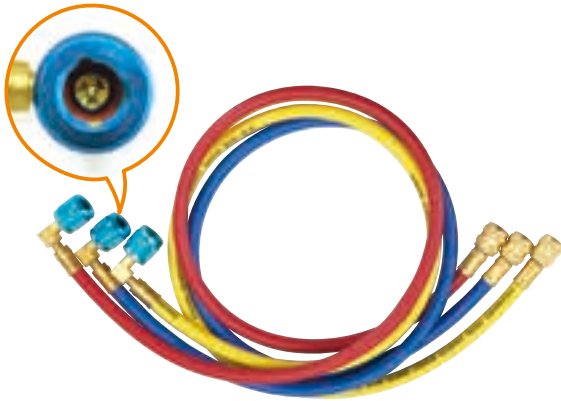

#### HOSE W/AUTO SHUT-OFF VALVE

ITEM	LENGTH	CONNECTION THREAD	REFRIGERANT
CH-336RYB-SASL CH-360RYB-SASL CH-372RYB-SASL CH-396RYB-SASL	3PCS×36" 3PCS×60" 3PCS×72" 3PCS×96"	1/4"-180'×1/4"-90' SAE	R134A
CH-336RYB-S410ASL CH-360RYB-S410ASL CH-372RYB-S410ASL CH-396RYB-S410ASL	3PCS×36" 3PCS×60" 3PCS×72" 3PCS×96"	1/4"-180'×1/4"-90' SAE	R410
CH-336RYB-410ASL CH-360RYB-410ASL CH-372RYB-410ASL CH-396RYB-410ASL	3PCS×36" 3PCS×60" 3PCS×72" 3PCS×96"	1/4"-180'×5/16"-90' SAE	R410
CH-336RYB-S410AASL CH-360RYB-S410AASL CH-372RYB-S410AASL CH-396RYB-S410AASL	3PCS×36" 3PCS×60" 3PCS×72" 3PCS×96"	5/16"-180'×5/16"-90' SAE	R410
CH-336RYB-41005ASL CH-360RYB-41005ASL CH-372RYB-41005ASL CH-396RYB-41005ASL	3PCS×36" 3PCS×60" 3PCS×72" 3PCS×96"	R.B:1/4"-180' × 5/16"-90' SAE Y: 1/4"-180'×1/4"-90'	R410

## 附開關冷媒管

### HOSE & SHUT-OFF VALVE FOR 22/134/410A/R32/HFO-1234YF

- CONNECTION THREAD CAN BE 1/4" SAE, 5/16" SAE OR 1/2" ACME.
- SPECIAL LENGTH OR INDIVIDUAL CHARGING HOSE IS AVAILABLE.

new

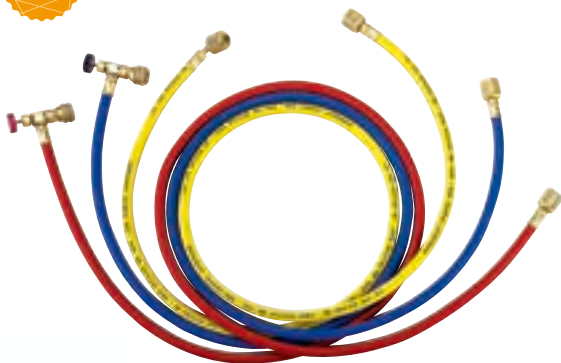

#### HOSE W/AUTO SHUT-OFF VALVE

ITEM	LENGTH	CONNECTION THREAD	REFRIGERANT
CH-336RYB-CV CH-360RYB-CV CH-372RYB-CV CH-396RYB-CV	3PCS×36" 3PCS×60" 3PCS×72" 3PCS×96"	R.B. 1/4"SAE x W/CH-343 (1/4") CONTROL VALVE Y: 1/4x1/4-45'	R134A
CH-336RYB-CV410 CH-360RYB-CV410 CH-372RYB-CV410 CH-396RYB-CV410	3PCS×36" 3PCS×60" 3PCS×72" 3PCS×96"	R.B. 1/4"SAE x W/CH-343 (1/4") CONTROL VALVE Y: 1/4x1/4-45'	R410
CH-336RYB-CV4105 CH-360RYB-CV4105 CH-372RYB-CV4105 CH-396RYB-CV4105	3PCS×36" 3PCS×60" 3PCS×72" 3PCS×96"	R.B. 1/4"SAE x W/CH-343 (5/16") CONTROL VALVE Y: 1/4x1/4-45'	R410



#### ▶▶▶ CH-555

1/2" ACME can tap valve and another side with low pressure quick coupler with R134A hose (total length 50cm).



#### ▶▶▶ CH-333

1/2" ACME can tap valve and another side with 1/4" SAE connection with R134A hose (total length 50cm).

# 球型開關冷媒管

## HOSE & SHUT-OFF BALL VALVE FOR 22/134/410A/R32/HFO-1234YF

- CONNECTION THREAD CAN BE 1/4" SAE, 5/16" SAE OR 1/2" ACME.
- SPECIAL LENGTH OR INDIVIDUAL CHARGING HOSE IS AVAILABLE.

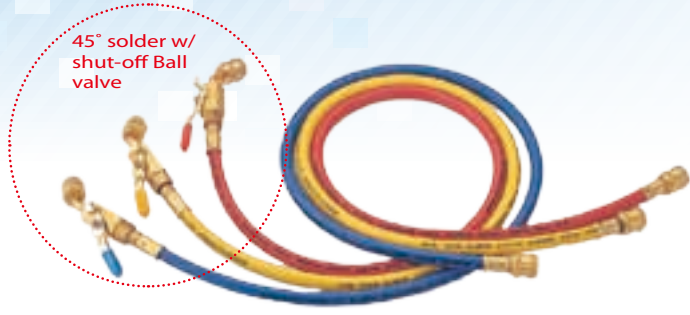

含球閥冷媒管組



含球閥冷媒管組

### HOSE W/SHUT-OFF BALL VALVE

ITEM	LENGTH	CONNECTION THREAD	REFRIGERANT
CH-336RYB-SH CH-360RYB-SH CH-372RYB-SH CH-396RYB-SH	3PCS×36" 3PCS×60" 3PCS×72" 3PCS×96"	1/4"SAE	R134A
CH-336RYB-SH410 CH-360RYB-SH410 CH-372RYB-SH410	3PCS×36" 3PCS×60" 3PCS×72"	1/4"SAE	R410
CH-336RYB-SHR410 CH-360RYB-SHR410 CH-372RYB-SHR410	3PCS×36" 3PCS×60" 3PCS×72"	1/4"×5/16"SAE-45'	R410
CH-336RYB-SH-A1 CH-360RYB-SH-A1 CH-372RYB-SH-A1	3PCS×36" 3PCS×60" 3PCS×72"	5/16"SAE	R410
CH-336RYB-SH4105 CH-360RYB-SH4105 CH-372RYB-SH4105	3PCS×36" 3PCS×60" 3PCS×72"	R.B: 1/4×5/16-45' Y:1/4×1/4-45'	R410
<b>NEW!!</b> CH-336RYB-SH-B CH-360RYB-SH-B CH-372RYB-SH-B CH-396RYB-SH-B	3PCS×36" 3PCS×60" 3PCS×72" 3PCS×96"	5/16"×1/4"SAE-45'	R410

### HOSE W/SHUT-OFF BALL VALVE

ITEM	LENGTH	CONNECTION THREAD	REFRIGERANT
CH-336RYB-407L CH-360RYB-407L CH-372RYB-407L	3PCS×36" 3PCS×60" 3PCS×72"	1/4"SAE	R134A
CH-336RYB-407LA CH-360RYB-407LA CH-372RYB-407LA	3PCS×36" 3PCS×60" 3PCS×72"	1/4"SAE	R410
CH-336RYB-R410L CH-360RYB-R410L CH-372RYB-R410L	3PCS×36" 3PCS×60" 3PCS×72"	1/4"×5/16"SAE-45'	R410
CH-336RYB-410LSH CH-360RYB-410LSH CH-372RYB-410LSH	3PCS×36" 3PCS×60" 3PCS×72"	5/16"SAE	R410
CH-336RYB-41005L CH-360RYB-41005L CH-372RYB-41005L	3PCS×36" 3PCS×60" 3PCS×72"	R.B: 1/4×5/16-45' Y:1/4×1/4-45'	R410
<b>NEW!!</b> CH-336RYB-LSHB CH-360RYB-LSHB CH-372RYB-LSHB CH-396RYB-LSHB	3PCS×36" 3PCS×60" 3PCS×72" 3PCS×96"	5/16"×1/4"SAE-45'	R410



#### Hose w/shut-off ball valve

- ▶▶▶ CH-15R/Y/B-SH  
1/4" male x 1/4" female
- ▶▶▶ CH-15R/Y/B-IT  
5/16" male x 5/16" female
- ▶▶▶ CH-15R/Y/B -410SH  
1/4" male x 1/4" female for R410
- ▶▶▶ CH-15R/Y/B-410IT  
5/16" male x 5/16" female for R410



#### W/shut-off ball valve

- ▶▶▶ CH-15R/Y/B HOSE  
Auto conditioning hose with 3 different colors.  
For red, yellow or blue hose.  
Total length 15cm  
1/4" SAE M. x 1/4" SAE 45°  
for 5/16" SAE M.x.F.

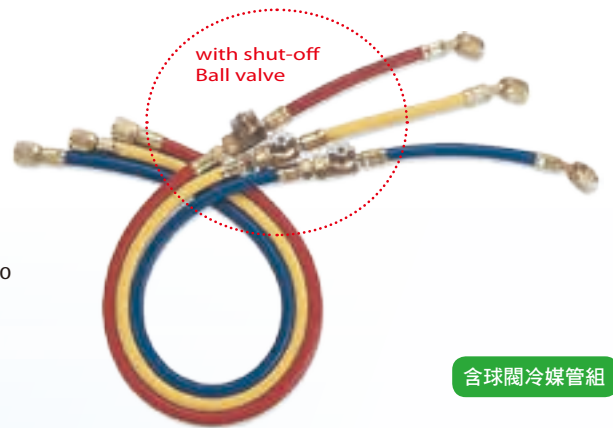

含球閥冷媒管組

### HOSE W/SHUT-OFF BALL VALVE

ITEM	LENGTH	CONNECTION THREAD	REFRIGERANT
CH-336RYB-L CH-360RYB-L CH-372RYB-L CH-396RYB-L	3PCS×36" 3PCS×60" 3PCS×72" 3PCS×96"	1/4"SAE	R134A

# 冷媒管 HOSE

- CONNECTION THREAD CAN BE 1/4" SAE, 5/16" SAE OR 1/2" ACME.
- SPECIAL LENGTH OR INDIVIDUAL CHARGING HOSE IS AVAILABLE.

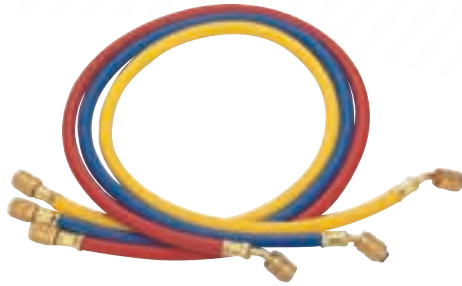

ITEM	LENGTH	CONNECTION THREAD	REFRIGERANT
CT-336RYB	3PCS×36"	1/4"SAE	R12
CT-360RYB	3PCS×60"		
CT-372RYB	3PCS×72"		
CT-396RYB	3PCS×96"		

ITEM	LENGTH	CONNECTION THREAD	REFRIGERANT
CH-336RYB-S CH-360RYB-S CH-372RYB-S CH-396RYB-S	3PCS×36" 3PCS×60" 3PCS×72" 3PCS×96"	1/4"SAE	R134A
CH-336RYB-S410 CH-360RYB-S410 CH-372RYB-S410	3PCS×36" 3PCS×60" 3PCS×72"	1/4"SAE	R410
CH-336RYB-410 CH-360RYB-410 CH-372RYB-410	3PCS×36" 3PCS×60" 3PCS×72"	1/4"×5/16"SAE-45'	R410
CH-336RYB-S410-A CH-360RYB-S410-A CH-372RYB-S410-A	3PCS×36" 3PCS×60" 3PCS×72"	5/16"SAE	R410
CH-336RYB-41005 CH-360RYB-41005 CH-372RYB-41005	3PCS×36" 3PCS×60" 3PCS×72"	R.B: 1/4×5/16-45' Y:1/4×1/4-45'	R410
<b>NEW!!</b> CH-336RYB-S410-B CH-360RYB-S410-B CH-372RYB-S410-B CH-396RYB-S410-B	3PCS×36" 3PCS×60" 3PCS×72" 3PCS×96"	5/16"×1/4"SAE-45'	R410

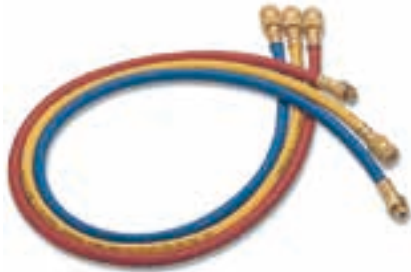

ITEM	LENGTH	CONNECTION THREAD	REFRIGERANT
CH-336RYB-M CH-360RYB-M CH-372RYB-M CH-396RYB-M	3PCS×36" 3PCS×60" 3PCS×72" 3PCS×96"	R.B: 1/2"ACME×(M14×1.5) Y: 1/2"ACME×1/2"ACME	R134A



ITEM	LENGTH	CONNECTION THREAD	REFRIGERANT
CH-336RYB-1234 CH-360RYB-1234 CH-372RYB-1234 CH-396RYB-1234	3PCS×36" 3PCS×60" 3PCS×72" 3PCS×96"	R.B: M12×P1.5 M.F. W/O-RING -180' X M12×P1.5 M.F. W/O-RING -180' Y: M12×P1.5 M.F. W/O-RING -180' X 1/2"ACME F.F. LH(左牙)	HFO-1234YF

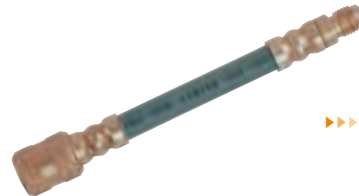

### ▶▶▶ CH-N408

Auto air conditioning adapter for Audi, 1/2"ACME. F. x 1/4 SAE. M. W/9520C valve core



### Auto charging adapters & hoses complete kit

#### ▶▶▶ CH-135

Blister packing on a card. 1/4" Mx1/4"F, 1/4" Mx3/16"F 1/4" Mx1/8"F adapter. Hose/B: 1/4"M x 3/16"F Hose/R: 1/4"M x 1/8"F



3/8"×3/8" sae both straight end for R12 w/o depressor core

- ▶▶▶ CT-36Y-06  
1PC 36" hose
- ▶▶▶ CT-60Y-06  
1PC 60" hose
- ▶▶▶ CT-72Y-06  
1PC 72" hose

\*\* Customized length \*\*



3/8"×3/8" sae both straight end for R410 w/o depressor core

- ▶▶▶ CH-36BK-06  
1PC 36" hose
- ▶▶▶ CH-60BK-06  
1PC 60" hose
- ▶▶▶ CH-72BK-06  
1PC 72" hose

\*\* Customized length \*\*



## 手提式錶組 (鐵弗龍墊片式) TEFLON DIAPHRAGM MANIFOLD

R12/22/134/404/407/410/R32/HFO-1234YF ALL OPTIONAL

### PACKED EASY TO CARRY

Carry box suitable piston type manifold also.

可任意搭配各種型式冷媒錶刻度  
(80mm錶除外) 快速接頭及任何一  
種的鋁錶架, 冷媒管。  
冷媒管也可搭配附開關裝置。



Worldwide patent on case design

Patent NO. :

US 6823, 688B1

US D500, 508s

M252855

D10225 / 000125D18-0001

3102937 / 684884

### CH-J36G-C

R134. Manifold Set. 1/4" SAE thread  
W/QC-LM. HM. CH-336 RYB-S.

### CH-J60G-C

R134. Manifold Set. 1/4" SAE thread  
W/QC-LM. HM. CH-360 RYB-S.

### CH-J72G-C

R134. Manifold Set. 1/4" SAE thread  
W/QC-LM. HM. CH-372 RYB-S.

## 手提式錶組 (球閥式) BALL VALVE TYPE MANIFOLD



Complete kit in a hand carrying case. Manifold is screw fixed on carrying case. No need to release manifold will can be operated.

\* Wordwide patent on case design.

\* Gauge with rubber protective boots.

\* Manifold with R134 gauges, the connection thread can be 1/4" SAE or 1/2" ACME (1/4" SAE with QC-LM & QC-HM or QC-12 quick couplers) (1/2" ACME with QC-L & QC-H quick coupler)

\* Manifold with R410 gauge, the connection thread can be 1/4" SAE or 5/16" SAE Hose with ball valve shut-off.

\* Manifold body can be chosen blue or black color.

\* Case can be chosen silver or black color.

### CH-M36G-C

R134. Manifold Set. 1/4" SAE thread  
W/QC-LM. HM. CH-336 RYB-S.

### CH-M60G-C

R134. Manifold Set. 1/4" SAE thread  
W/QC-LM. HM. CH-360 RYB-S.

### CH-M72G-C

R134. Manifold Set. 1/4" SAE thread  
W/QC-LM. HM. CH-372 RYB-S.

可供選配示意圖



### OPEN TO PULL OUT HOSE

操作示意圖



### OPERATING



Manifold with R134 gauges, the connection thread can be 1/4" SAE or 1/2" ACME. (1/4" SAE with QC-LM & QC-HM or QC-12 quick couplers) (1/2" ACME with QC-L & QC-H quick coupler)

# → 錶組 (球閥式)

## BALL VALVE TYPE MANIFOLD

- MANIFOLD ASSEMBLED W/R12/22/32/134/404/407/410/ HFO-1234YF ALL OPTIONAL GAUGE, 1/4", 5/16" SAE OR 1/2" ACME CONNECTION COMPLETE SET IN A BLOW CASE OF BLISTER BOX.
- BELOW MANIFOLD CAN BE CHOSEN TO MATCH WITH ANY MODEL HOSE, AND QUICK COUPLER.
- MADE OF ALUMINUM, BLUE OR BLACK COLOR CAN BE CHOSEN.

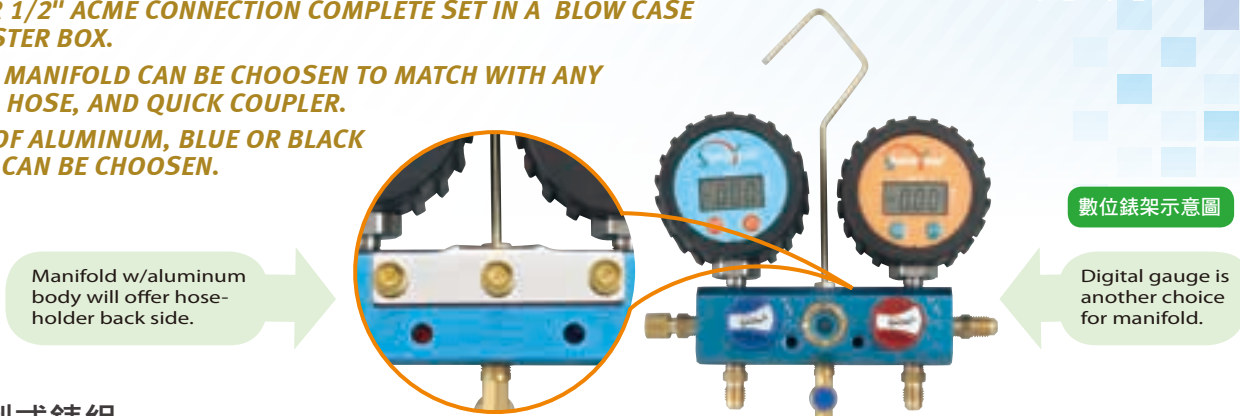

### 無視窗型式錶組

#### ▶▶ BV-01G

- \* Manifold with R134 gauges, the connection thread can be 1/4" SAE or 1/2" ACME (1/4" SAE with QC-LM & QC-HM or QC-12 quick couplers) (1/2" ACME with QC-L & QC-H quick coupler)
- \* Manifold with R410 gauge, the connection thread can be 1/4" SAE or 5/16" SAE hose with shut-off ball valve .

#### ▶▶ BV-136G

With 3 x 36" hose. R134. W/QC-12. 1/4" SAE

#### ▶▶ BV-160G

With 3 x 60" hose. R134. W/QC-12. 1/4" SAE

#### ▶▶ BV-172G

With 3 x 72" hose. R134. W/QC-12. 1/4" SAE.

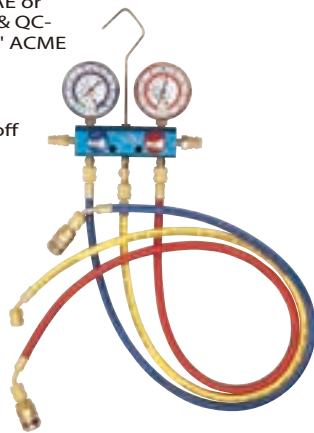

#### ▶▶ BV-02G

- \* Manifold with R134 gauges, the connection thread can be 1/4". W/shut-off ball valve Hose.
- \* Manifold with R410 gauge, the connection thread can be 1/4" SAE or 5/16" SAE hose with shut-off ball valve .

#### ▶▶ BV-236G

With 3 x 36" shut-off ball valve hose. R410. without QC. 1/4" SAE.

#### ▶▶ BV-260G

With 3 x 60" shut-off ball valve hose. R410. without QC. 1/4" SAE.

#### ▶▶ BV-272G

With 3 x 72" shut-off ball valve hose. R410. without QC. 1/4" SAE.

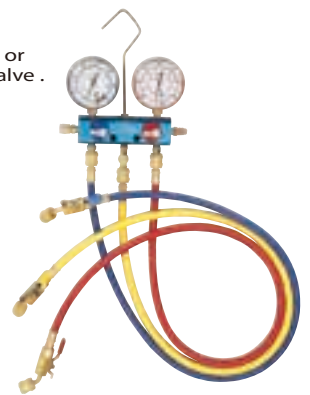

### 視窗型式錶組

#### ▶▶ BVL-01G

- \* Manifold with R134 gauges, the connection thread can be 1/4" SAE or 1/2" ACME (1/4" SAE with QC-LM & QC-HM or QC-12 quick couplers) (1/2" ACME with QC-L & QC-H quick coupler)
- \* Manifold with R410 gauge, the connection thread can be 1/4" SAE or 5/16" SAE hose with shut-off ball valve .

#### ▶▶ BVL-136G

With 3x36" hose. R134. QC-LM. HM. 1/4" SAE.

#### ▶▶ BVL-160G

With 3 x 60" hose. R134. QC-LM. HM. 1/4" SAE.

#### ▶▶ BVL-172G

With 3 x 72" hose. R134. QC-LM. HM. 1/4" SAE.

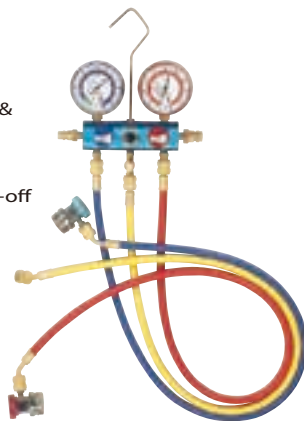

#### ▶▶ BVL-02G

- \* Manifold with R134 gauges, the connection thread can be 1/4" SAE W/shut-off ball valve Hose.
- \* Manifold with R410 gauge, the connection thread can be 1/4" SAE or 5/16" SAE hose with ball valve shut-off.

#### ▶▶ BVL-236G

With 3 x 36" shut-off ball valve hose. R410. 1/4" SAE. Hose without QC.

#### ▶▶ BVL-260G

With 3 x 60" shut-off ball valve hose. R410. 1/4" SAE. hose without QC.

#### ▶▶ BVL-272G

With 3 x 72" shut-off ball valve hose. R410. 1/4" SAE. hose without QC.

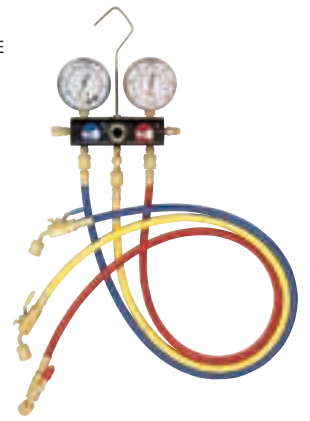

### 外接視窗錶組

#### ▶▶ BVS-01G

- \* Manifold with CT-800-04 x 02NPT sight glass the connection thread can be 1/4" SAE with QC-LM & QC-HM or QC-12 quick couplers)

#### ▶▶ BVS-136G

With 3 x 36" hose. R134. 1/4" SAE. W/QC-12

#### ▶▶ BVS-160G

With 3 x 60" hose. R134. 1/4" SAE. W/QC-12

#### ▶▶ BVS-172G

With 3 x 72" hose. R134. 1/4" SAE. W/QC-12

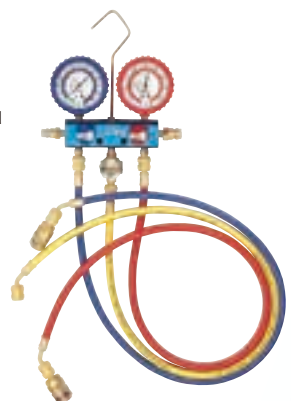

#### ▶▶ BVS-02G

- \* Manifold with CT-800-04 x 02NPT sight glass, the connection thread can be 1/4" SAE W/Shut-off ball valve hose.
- \* Manifold with R410 gauge, the connection thread can be 1/4" SAE or 5/16" SAE hose with shut-off ball valve.

#### ▶▶ BVS-236G

With 3 x 36" shut-off ball valve hose. R410. hose 1/4" SAE.

#### ▶▶ BVS-260G

With 3 x 60" shut-off ball valve hose. R410. hose 1/4" SAE.

#### ▶▶ BVS-272G

With 3 x 72" shut-off ball valve hose. R410. hose 1/4" SAE.

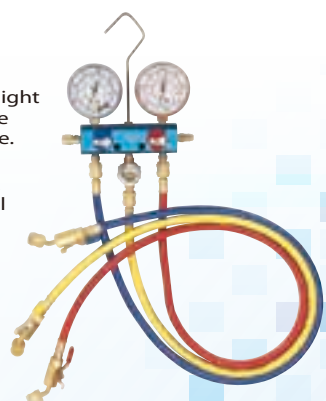

Picture with rubber protective boots is for reference. Standard product w/o rubber protective boots.  
\* Above manifold body hose can be selected According to your needs.

## → 錶組 (球閥式) BALL VALVE TYPE MANIFOLD

R12/22/32/134/404/407/410/HFO-1234YF ALL OPTIONAL

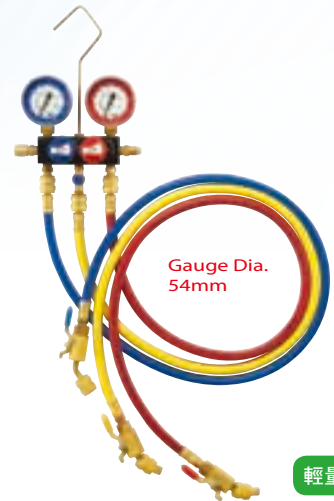
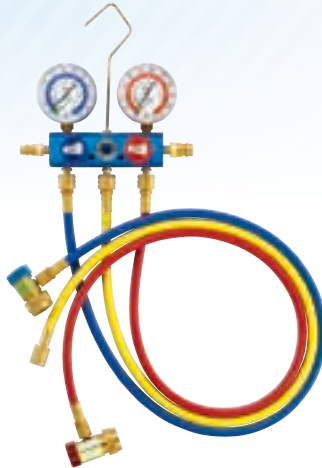
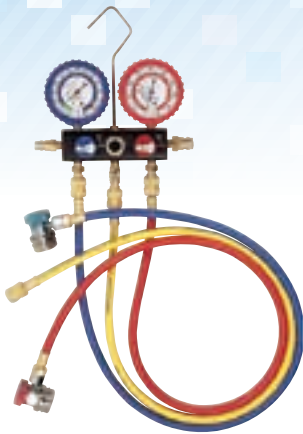

輕量型

- \* Gauge with rubber protective boots is for reference.
- \* Manifold with R134 gauges, the connection thread can be 1/4" SAE or 1/2" ACME.
- \* 1/4" SAE with QC-LM & HM or QC-12 quick couplers.
- 1/2" ACME with QC-L & QC-H quick coupler.
- ▶▶▶ **CH-N36G**  
with 3 x 36" hose.  
R134. QC-L. H.1/2" ACME.
- ▶▶▶ **CH-N60G**  
with 3 x 60" hose.  
R134. QC-L. H.1/2" ACME.
- ▶▶▶ **CH-N72G**  
with 3 x 72" hose.  
R134. QC-L. H.1/2" ACME.

### HFO-1234YF MANIFOLD

- \* R.B.: M12xP1.5 M.F. W/O-RING -180' X M12xP1.5 M.F. W/O-RING -180'.
- \* Y.: M12xP1.5 M.F. W/O-RING -180' X 1/2" ACME F.F. LH (左牙)
- ▶▶▶ **BVL-YF01G**  
Manifold with HFO-1234YF gauges.
- ▶▶▶ **BVL-YF136G**  
With 3x36" hose. QC-L1234 & QC-H1234 quick coupler.
- ▶▶▶ **BVL-YF160G**  
With 3x60" hose. QC-L1234 & QC-H1234 quick coupler.
- ▶▶▶ **BVL-YF172G**  
With 3x72" hose. QC-L1234 & QC-H1234 quick coupler.

### LIGHT BALL VALVE TYPE MANIFOLD

- ▶▶▶ **BVJ-02**  
Ball valve type manifold body 1/4" SAE w/hook & charging valve.  
Manifold body size:  
90(L)x30.5(W)x23(H)mm
- ▶▶▶ **BVJ-02G**  
W/gauge RG-410-500-34MI & RG-410-800-34MI, PSI, BAR, °C
- W/ shut-off ball valve**
- ▶▶▶ **BVJ-236G**  
3 x R410 hose 36".
- ▶▶▶ **BVJ-260G**  
3 x R410 hose 60".
- ▶▶▶ **BVJ-272G**  
3 x R410 hose 72".

## → 錶組 (有視窗針閥式) TESTING MANIFOLD GAUGE SETS

R12/22/32/134/404/407/410/HFO-1234YF ALL OPTIONAL

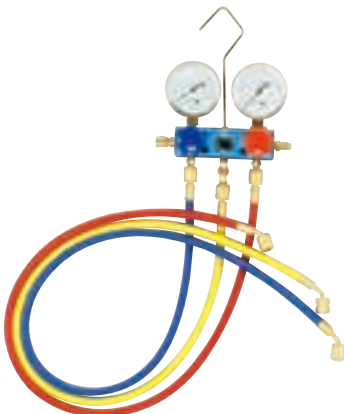

- Manifold with 3 pcs hoses, 1/4" SAE connection for R12.
- ▶▶▶ **CH-136G**  
with 3pcs 36" hoses.
  - ▶▶▶ **CH-160G**  
with 3pcs 60" hoses.
  - ▶▶▶ **CH-172G**  
with 3pcs 72" hoses.

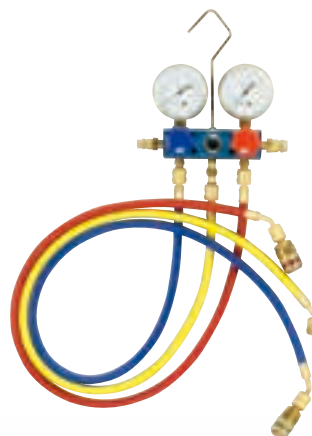

- Manifold with 3 pcs hoses, 2pcs quick couplers. 1/4" SAE connection for R134A..
- ▶▶▶ **CH-236G**  
with 3pcs 36" hoses, QC-12.
  - ▶▶▶ **CH-260G**  
with 3pcs 60" hoses, QC-12.
  - ▶▶▶ **CH-272G**  
with 3pcs 72" hoses, QC-12.

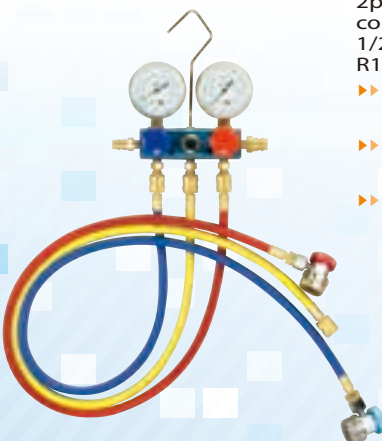

- Manifold with 3 pcs hoses, 2pcs adjustable quick couplers. 1/2" ACME connection for R134A.
- ▶▶▶ **CH-336G**  
with 3pcs 36" hoses, QC-L,H.
  - ▶▶▶ **CH-360G**  
with 3pcs 60" hoses, QC-L,H.
  - ▶▶▶ **CH-372G**  
with 3pcs 72" hoses, QC-L,H.

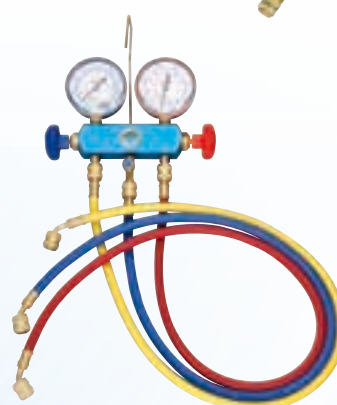

- ▶▶▶ **CH-RS01**  
Manifold body 1/4" SAE w/sight glass and hook
- ▶▶▶ **CH-RS01G**  
Manifold w/gauge, R12,22,134A,°C,PSI,KPA.
- ▶▶▶ **CH-RS36G**  
Manifold set, 3\*36" hose
- ▶▶▶ **CH-RS60G**  
Manifold set, 3\*60" hose
- ▶▶▶ **CH-RS72G**  
Manifold set, 3\*72" hose



# ➔ 錶組 (有視窗針閥式)

## TESTING MANIFOLD GAUGE SETS-PISTON TYPE

R12/22/32/134/404/407/410/HFO-1234YF ALL OPTIONAL

\*\* Handwheel with soft material. 1/4" SAE \*\*    \*\* Connection thread can be 5/16" SAE \*\*

Manifold 1/4" SAE  
Complete set in a carrying plastic case.

- ▶▶▶ **CH-736G**  
3pcs 36" hoses.  
w/QC-12
- ▶▶▶ **CH-760G**  
3pcs 60" hoses.  
w/QC-12
- ▶▶▶ **CH-772G**  
3pcs 72" hoses.  
w/QC-12



Manifold 1/2" ACME  
Complete set in a carrying plastic case.

- ▶▶▶ **CH-836G**  
3pcs 36" hoses.  
w/QC-L,H
- ▶▶▶ **CH-860G**  
3pcs 60" hoses.  
w/QC-L,H
- ▶▶▶ **CH-872G**  
3pcs 72" hoses.  
w/QC-L,H

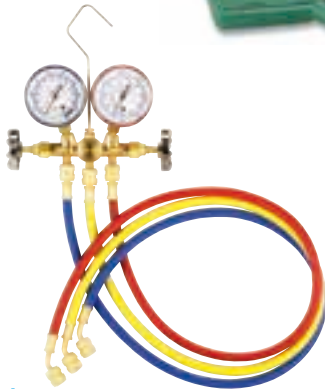

- ▶▶▶ **CT-501**  
Sight glass brass testing manifold body with hook, hose holder and two handwheels.
- ▶▶▶ **CT-501G**  
Sight glass brass testing manifold body with hook, hose holder and two handwheels.  
w/RG-250/500 gauge.
- ▶▶▶ **CT-536G**  
With 3 pcs 36" charging hoses for R12.
- ▶▶▶ **CT-560G**  
With 3pcs 60" charging hoses.
- ▶▶▶ **CT-572G**  
With 3pcs 72" charging hoses.

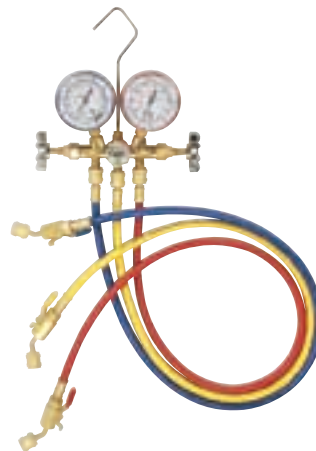

- \* Brass manifold w/ sight glass, hose with shut-off ball valve.
- \* For R410A connection thread can be 1/4" SAE or 5/16" SAE.
- ▶▶▶ **CH-536G-L**  
with 3 x 36" ball valve hose. R12. 1/4" SAE.
- ▶▶▶ **CH-560G-L**  
with 3 x 60" ball valve hose. R12. 1/4" SAE.
- ▶▶▶ **CH-572G-L**  
with 3 x 72" ball valve hose. R12. 1/4" SAE.

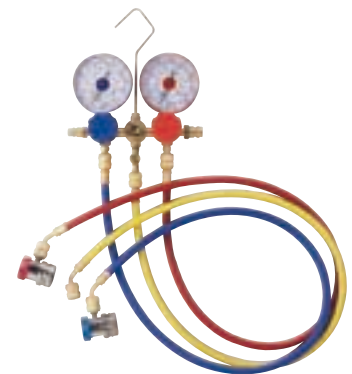

- ▶▶▶ **CH-Q01**  
Manifold body for 1/4" SAE
- ▶▶▶ **CH-Q01G**  
R22,134,404,407 manifold set w/80mm Gauge
- ▶▶▶ **CH-Q36G**  
R134 manifold set, 3x36" hose w/QC-LM, QC-HM
- ▶▶▶ **CH-Q60G**  
R134 manifold set, 3x60" hose w/QC-LM, QC-HM
- ▶▶▶ **CH-Q72G**  
R134 manifold set, 3x72" hose w/QC-LM, QC-HM

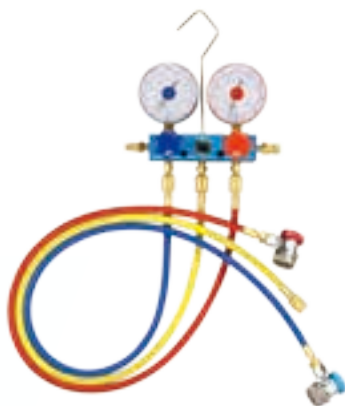

- Manifold R22, 134, 404,407 with 3pcs hoses, 2pcs adjustable quick couplers and 2pcs 80mm dia. gauge. 1/2" ACME connection.
- ▶▶▶ **A-36G**  
with 3pcs 36" hoses, QC-L,H
- ▶▶▶ **A-60G**  
with 3pcs 60" hoses, QC-L,H
- ▶▶▶ **A-72G**  
with 3pcs 72" hoses, QC-L,H

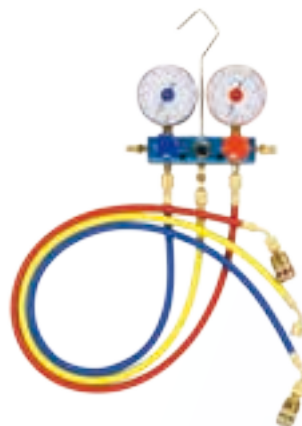

- Manifold for R22,134,404,407 with 3pcs hoses, 2pcs quick couplers and 2pcs 80mm dia.gauge.1/4" SAE connection.
- ▶▶▶ **B-36G**  
with 3pcs 36" hoses, QC-12
- ▶▶▶ **B-60G**  
with 3pcs 60" hoses, QC-12
- ▶▶▶ **B-72G**  
with 3pcs 72" hoses, QC-12



- Manifold for R134A with 3pcs hoses and sight glass, 2pcs adjustable quick couplers, 1/4" SAE connection for R134A can be used with QC-12
- ▶▶▶ **C-36G**  
with 3pcs 36" hoses, QC-LM,HM
- ▶▶▶ **C-60G**  
with 3pcs 60" hoses, QC-LM,HM
- ▶▶▶ **C-72G**  
with 3pcs 72" hoses, QC-LM,HM

## → 錶組 (無視窗針閥式) TESTING MANIFOLD GAUGE SETS-PISTON TYPE

R12/22/32/134/404/407/410/HFO-1234YF ALL OPTIONAL

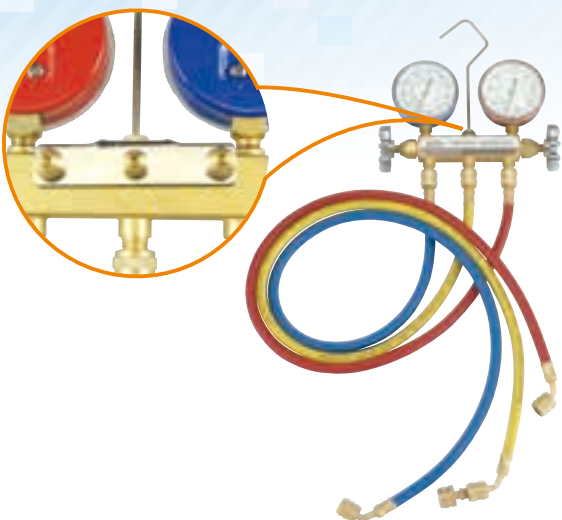

Manifold with 3 pcs hoses, 1/4"SAE connection for R12 & R134A

- ▶▶▶ **BP-136G**  
with 3pcs 36" hoses
- ▶▶▶ **BP-160G**  
with 3pcs 60" hoses
- ▶▶▶ **BP-172G**  
with 3pcs 72" hoses

\*Manifold with R22,R134a. R410 PSI KG/CM<sup>2</sup> gauge

\*With R410 hose w/hose-holder

\*R.B.:1/4" x 5/16"-45' & Y.:1/4" x 1/4" - 45'

\*W/1pc cylinder adapter SCA-04M x 05F (1/4"M.x5/16"F.)

- ▶▶▶ **BP-236G-21405**  
with 3pcs 36" hoses
- ▶▶▶ **BP-260G-21405**  
with 3pcs 60" hoses
- ▶▶▶ **BP-272G-21405**  
with 3pcs 72" hoses

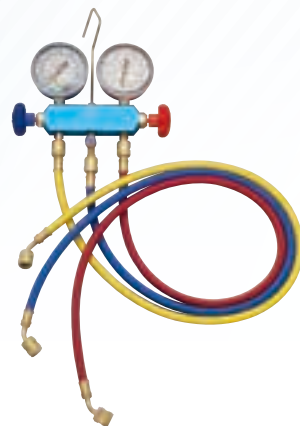

- ▶▶▶ **CH-R01**  
Manifold body 1/4" SAE w/hook, only
- ▶▶▶ **CH-R01G**  
Manifold w/gauge, R12, 22, 134A, °C, PSI, KPA.
- ▶▶▶ **CH-R36G**  
Manifold set, 3 x 36" hose
- ▶▶▶ **CH-R60G**  
Manifold set, 3 x 60" hose
- ▶▶▶ **CH-R72G**  
Manifold set, 3 x 72" hose



- ▶▶▶ **CT-601**  
Testing manifold body with hook, hose holder and two handwheels.
- ▶▶▶ **CT-601G**  
Testing manifold body with hook, hose holder and two handwheels. w/RG-250/500 gauge.
- ▶▶▶ **CT-636G**  
With 3 pcs 36" charging hoses.
- ▶▶▶ **CT-660G**  
With 3pcs 60" charging hoses.
- ▶▶▶ **CT-672G**  
With 3pcs 72" charging hoses.

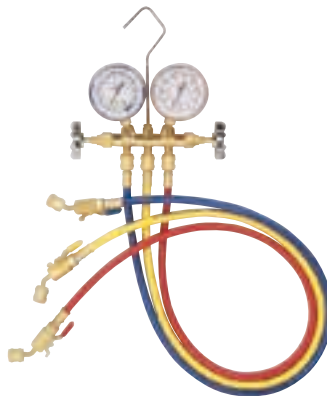

- \* Brass manifold w/o sight glass, hose with ball valve.
- \* Gauge can be for R12 or R134 or R410A.
- \* For R410A connection thread can be 1/4" SAE or 5/16" SAE.
- ▶▶▶ **CH-636G-L**  
with 3 x 36" ball valve hose. R12. 1/4" SAE.
- ▶▶▶ **CH-660G-L**  
with 3 x 60" ball valve hose. R12. 1/4" SAE.
- ▶▶▶ **CH-672G-L**  
with 3 x 72" ball valve hose. R12. 1/4" SAE.

## → 錶架用零件 PARTS FOR MANIFOLD

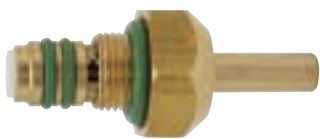

- ▶▶▶ **136GATO**  
Hex nut & T-connector for CH-136G series

- ▶▶▶ **136GATO-R**  
W/OP136HR red knob

- ▶▶▶ **136GATO-B**  
W/OP136HB blue knob

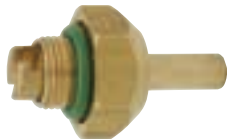

- ▶▶▶ **136GAT**  
Hex nut & T-connector for 136GATO for CH-136G series



- ▶▶▶ **0GBBVH**  
Hex brass nut for ball valve type manifold



- ▶▶▶ **136G-O**  
Brass nut w/o-ring for 136GATO for CH-136G.CH-R01. CH-RS01.CH-471.CH-471S series



- ▶▶▶ **0GBBV-T**  
T-connector for ball valve type manifold



- ▶▶▶ **0GB466-0**  
Brass nut w/o-ring for CH-466



- ▶▶▶ **501G-O**  
Brass nut w/o-ring for CT-501.601 series



- ▶▶▶ **OZ501**  
Zinc knob for CT-501.601.BP-01 series



- ▶▶▶ **SGSET**  
Glass & o-ring & teflon washer for sight glass of all manifolds (except for CH-R01 & CH-RS01)



- ▶▶▶ **0WGB134**  
Brass washer for sight glass of all manifolds (except for CH-R01 & CH-RS01)

# 鐵弗龍墊片式錶組

## TEFLON DIAPHRAGM TYPE MANIFOLD

R12/22/32/134/404/407/410/HFO-1234YF ALL OPTIONAL



### 四通型錶組

可選擇有視窗型式

#### ▶▶ CH-KO1G

- \* Aluminum 4 way manifold with 3 x 1/4" SAE & 1 x 3/8" SAE connector.
- \* Length of hose can be chosen.
- \* RG-250A & RG-500A R12,22,134A, Psi, bar, °C manifold with aluminum blue body

\*\* Connection thread can be 5/16" SAE \*\*  
\*\* With sight glass is optional. \*\*



### 五通型錶組

#### TEFLON DIAPHRAGM TYPE (5 ways)

#### ▶▶ CH-KV01G-S410

- \* Aluminum 5 way manifold with 3 x 1/4" SAE & 1 x 1/4" SAE with CH-9520C and CT-640-04 & 1 x 3/8" SAE connector.
- \* C.F.PSI.Bar, with sight glass RG-410-500 / RG-410-800+RG-80VP (gauges are optional)

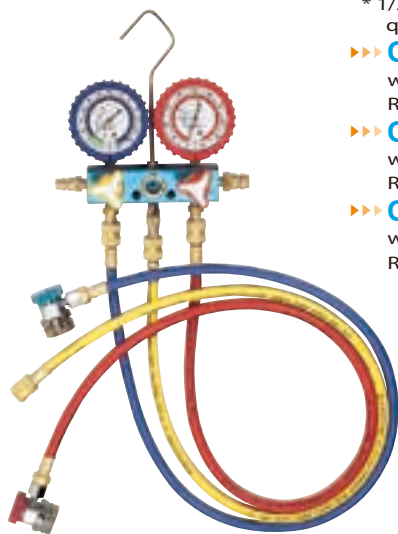

- \* Manifold with R134 gauges, the connection thread can be 1/4" SAE or 1/2" ACME.
- \* 1/4" SAE with QC-LM & HM or QC-12 quick couplers.
- \* 1/2" ACME with QC-L & QC-H quick coupler.

#### ▶▶ CH-L36G

with 3 x 36" hose.  
R134. 1/2" ACME . QC-L. H.

#### ▶▶ CH-L60G

with 3 x 60" hose.  
R134. 1/2" ACME . QC-L. H.

#### ▶▶ CH-L72G

with 3 x 72" hose.  
R134. 1/2" ACME. QC-L. H.

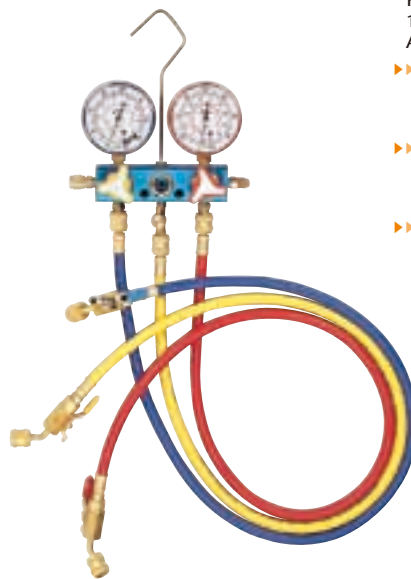

- \* Manifold with sight glass with R410A gauges, the connection thread can be 1/4" SAE or 5/16" SAE hose with shut-off ball valve.
- \* For R134 manifold w/QC Holder 1/4" SAE w/QC-LM/HM or 1/2" ACME, w/QC-L.H.

#### ▶▶ CH-P36G

with 3 x 36" ball valve hose.  
R410. Hose 1/4" SAE.

#### ▶▶ CH-P60G

with 3 x 60" ball valve hose.  
R410. Hose 1/4" SAE.

#### ▶▶ CH-P72G

with 3 x 72" ball valve hose.  
R410. Hose 1/4" SAE.

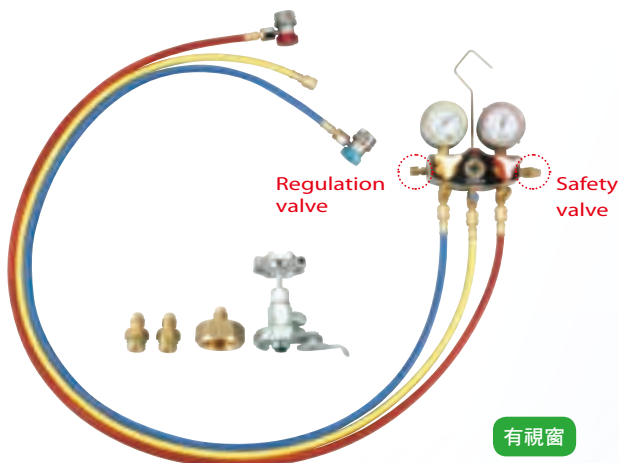

Regulation valve

Safety valve

有視窗

#### ▶▶ CH-R9134L

R134A manifold with sight glass.  
1pc CA-04 x 12 adapter,  
2pcs CA-04\*08 adapters,  
1pc can tap valve CH-340.

#### ▶▶ CH-R9134L-36

With 3pcs 36" hoses, w/QC-L,H

#### ▶▶ CH-R9134L-60

With 3pcs 60" hoses, w/QC-L,H

#### ▶▶ CH-R9134L-72

With 3pcs 72" hoses, w/QC-L,H



# 單錶錶組

## SINGLE MANIFOLD ASSEMBLED

示意圖

All of refrigerant gauge is available. You can also choose to attach rubber protective boot.

可選擇配件



▶▶▶ MPG-2474H

示意圖

Special length or individual hose is available. You can also choose to attach rubber protective boot.

可選擇配件



▶▶▶ CH-471

Piston type manifold body 1/4"SAE w/hook

▶▶▶ CH-471LG

Manifold w/R12,22,134A gauge low side RG-250N.

▶▶▶ CH-471LG-36"

W/2 x 36" hose

▶▶▶ CH-471LG-60"

W/2 x 60" hose

▶▶▶ CH-471LG-72"

W/2 x 72" hose



▶▶▶ CH-471CV

Piston type manifold body w/hook & charging valve

▶▶▶ CH-471CVLG

Manifold w/R12,22,134A gauge low side RG-250N.

▶▶▶ CH-471CVLG-36"

W/2 x 36" hose

▶▶▶ CH-471CVLG-60"

W/2 x 60" hose

▶▶▶ CH-471CVLG-72"

W/2 x 72" hose



▶▶▶ CH-471SCV

Piston type manifold body w/sight glass & hook & charging valve

▶▶▶ CH-471SCVLG

Piston type manifold body with low pressure gauge RG-250A R12,22,134A, bar & psi

▶▶▶ CH-471SCVLG-36"

W/2 x 36" hose

▶▶▶ CH-471SCVLG-60"

W/2 x 60" hose

▶▶▶ CH-471SCVLG-72"

W/2 x 72" hose

\*\* Can be high pressure gauge, special length or individual hose is available \*\*



Gauge Dia. 54mm

輕量型

### 輕量型單錶架

#### LIGHT BALL VALVE TYPE MANIFOLD

▶▶▶ CH-472BV

Ball valve type manifold body 1/4" SAE w/hook & charging valve, black body. Manifold body size: 38(L)x30.5(W)x23(H)mm.

▶▶▶ CH-472BV-34L

W/gauge RG-410-500-34MI, PSI, BAR, °C. Black body and blue knob.

▶▶▶ CH-472BV-34H

W/gauge RG-410-800-34MI, PSI, BAR, °C. Black body and red knob.



▶▶▶ CH-466

Single manifold without gauge.

▶▶▶ CH-466G

Single manifold with RG-250 or RG-500 gauge.

## 單錶錶組 SINGLE MANIFOLD ASSEMBLED

MANIFOLD BODY MADE OF ALUMINUM, BLUE OR BLACK COLOR CAN BE CHOSEN.  
R12/22/134/404/407/410 ALL OPTIONAL



▶▶ **CH-467BV-250**  
Ball valve type w/low pressure gauge  
RG-250A.



▶▶ **CH-467BV-500**  
Ball valve type w/high pressure gauge  
RG-500A.



▶▶ **CH-468BV-250**  
Ball valve type w/CT-800-04PT sight glass & low pressure gauge  
RG-250A.



▶▶ **CH-468BV-500**  
Ball valve type w/CT-800-04PT sight glass & high pressure gauge  
RG-500A.



▶▶ **CH-469-250**  
Piston type W/low pressure gauge  
RG-250A.



▶▶ **CH-469-500**  
Piston type w/high pressure gauge  
RG-500A.



▶▶ **CH-470-250**  
Piston type w/CT-800-04PT sight glass & low pressure gauge  
RG-250A.



▶▶ **CH-470-500**  
Piston type w/CT-800-04PT sight glass & high pressure gauge  
RG-500A.

## 錶架用零件 PARTS FOR MANIFOLD



▶▶ **0P136HR**  
Plastic red knob for CH-136G series



▶▶ **0P136HB**  
Plastic blue knob for CH-136G series



▶▶ **0PR136HR**  
Red rubber knob for piston type manifold



▶▶ **0PR136HB**  
Blue rubber knob for piston type manifold



▶▶ **0PBVHR**  
Red knob for ball valve type manifold



▶▶ **0PBVHB**  
Blue knob for ball valve type manifold



▶▶ **0PRBVHR**  
Red rubber knob for ball valve type manifold



▶▶ **0PRBVHB**  
Blue rubber knob for ball valve type manifold

## 錶護套 PROTECTIVE GAUGE BOOT



- ▶▶ NO.ORG-B-L  
Blue protective gauge boot for 80mm gauge
- ▶▶ NO.ORG-L  
Red protective gauge boot for 80mm gauge

- ▶▶ NO.ORG-B-S  
Blue protective gauge boot for 2-3/4" gauge dia.
- ▶▶ NO.ORG-S  
Red protective gauge boot for 2-3/4" gauge dia.

## 暫壓指針 MEMORY POINTER (RED)



- 嵌入式錶殼  
Embed type  
▶▶ OPRGEC-WP
- 旋蓋式錶殼  
Rotary type  
▶▶ OPRGC-WP

## 電子真空錶 DIGITAL VACUUM GAUGE



Item Code	Gauge Diameter	Vacuum Units	Refrigerant Scales
DG-VM	70mm	pascal, mbar, mm-Hg, inch-Hg, milli-Torr and micron.	10°F~122°F (-12°C~50°C)

## 電子錶 DIGITAL GAUGE - 1/8" NPT



Item Code	Gauge Diameter	Units	Refrigerant Scales
DG-700L DG-700H	68mm	PSI, Bar, kg/cm <sup>2</sup> , °C & °F, KPA, MPA	R12.22.32.134.404.407.410.507.HFO-1234YF R290.R600.R600a
DG-700L-SN DG-700H-SN	70mm	PSI, Bar, kg/cm <sup>2</sup> , °C & °F, KPA, MPA, In-Hg, cm-Hg, Atm	R12.22.134.404.407.410.507.32.1234-YF. R290.600.600A.502. R502.23.123.124. 408A.417A.427A. 448A.449A.452A.744

## 直立式含油冷媒錶 REFRIGERANT GAUGE - 1/8" NPT

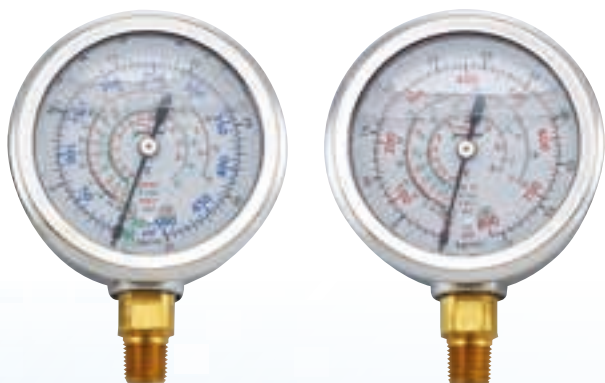

Item Code	Gauge Diameter	Units	Refrigerant Scales
RG-250GL-2447 RG-500GL-2447	2-1/2"	PSI, kg/cm <sup>2</sup> , °C	R22.134.404.407
RG-250GL-2474 RG-500GL-2474	2-1/2"	PSI, kg/cm <sup>2</sup> , °C	R22.134.407.410
<b>NEW!!</b> RG-250GL-2447N RG-500GL-2447N	2-1/2"	PSI, kg/cm <sup>2</sup> , °C	R22.134.404.407

## 玻璃錶面蓋冷媒錶 REFRIGERANT GAUGE - 1/8" NPT



Item Code	Gauge Diameter	Units	Refrigerant Scales
R-134G-250 R-134G-500	2-1/2"	PSI, kg/cm <sup>2</sup> , °C	R12.134



## 埋入式含油冷媒錶

REFRIGERANT GAUGE - 1/4" SAE

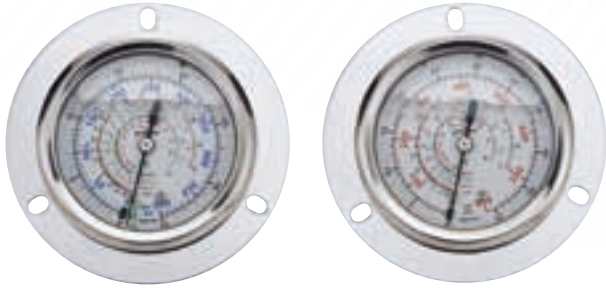

Item Code	Gauge Diameter	Units	Refrigerant Scales
CH-134GL-2447L CH-134GL-2447H	2-1/2"	PSI, kg/cm <sup>2</sup> , °C	R22.134. 404.407
CH-134GL-2474L CH-134GL-2474H	2-1/2"	PSI, kg/cm <sup>2</sup> , °C	R22.134. 407.410
<b>NEW!!</b> CH-134GL-2447LN CH-134GL-2447HN	2-1/2"	PSI, kg/cm <sup>2</sup> , °C	R22.134. 404.407

## 埋入式冷媒錶

REFRIGERANT GAUGE - 1/4" SAE



Item Code	Gauge Diameter	Units	Refrigerant Scales
FRG-250 KP FRG-500 KP	2-1/2"	PSI, kg/cm <sup>2</sup> , °C	R22.134

## 真空幫浦專用錶

VACUUM METER GAUGE



Item Code	Gauge Diameter	Units	Item Code	Gauge Diameter
RG-80VP	80mm	1000~0 MBAR PA=X100	RG-80VB	3"

## 迷你旋轉式塑膠蓋冷媒錶

REFRIGERANT GAUGE 1/8" NPT- MINI TYPE



Item Code	Gauge Diameter	Units	Refrigerant Scales
RG-410-500-34MI RG-410-800-34MI	54mm	PSI, Bar, °C	R32.410

## 嵌八式塑膠蓋冷媒錶

REFRIGERANT GAUGE - 1/8" NPT



Item Code	Gauge Diameter	Units	Refrigerant Scales
CH-134L-3417 CH-134H-3417	68mm	PSI, Bar, °C	R32.134. 407.410

Item Code	Gauge Diameter	Units	Refrigerant Scales
CH-134L-3421 CH-134H-3421	68mm	PSI, Bar, °C	R22.32. 134.410

# 嵌八式塑膠蓋冷媒錶

## REFRIGERANT GAUGE - 1/8" NPT



Item Code	Gauge Diameter	Units	Refrigerant Scales
<b>CH-134L-34</b> <b>CH-134H-34</b>	2-3/4"	PSI, kg/cm <sup>2</sup> , °C	R32.410
<b>NEW!!</b> <b>CH-134L-247</b> <b>CH-134H-247</b>	2-3/4"	PSI, kg/cm <sup>2</sup> , °C	R22.134.407

Item Code	Gauge Diameter	Units	Refrigerant Scales
<b>CH-134L-1234</b> <b>CH-134H-1234</b>	2-3/4"	PSI, Bar, °C	HFO-1234-YF



Item Code	Gauge Diameter	Units	Refrigerant Scales
<b>CH-134L-2447</b> <b>CH-134H-2447</b>	2-3/4"	PSI, kg/cm <sup>2</sup> , °C	R22.134.404.407
<b>CH-134L-2474</b> <b>CH-134H-2474</b>	2-3/4"	PSI, kg/cm <sup>2</sup> , °C	R22.134.407.410
<b>CH-134L-R22.407</b> <b>CH-134H-R22.407</b>	2-3/4"	PSI, Bar, °C	R22.407

Item Code	Gauge Diameter	Units	Refrigerant Scales
<b>CH-134L-R12</b> <b>CH-134H-R12</b>	2-3/4"	PSI, Bar, °C	R12.22.502
<b>CH-134L-R134</b> <b>CH-134H-R134</b>	2-3/4"	PSI, Bar, °C	R134.404
<b>CH-134L-R407</b> <b>CH-134H-R407</b>	2-3/4"	PSI, Bar, °C	R134.404.407

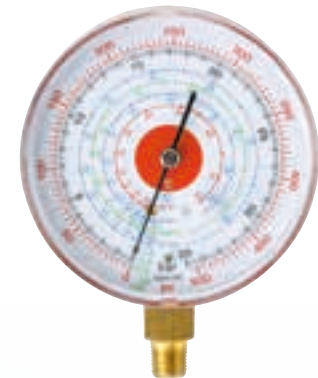

**new**

Item Code	Gauge Diameter	Units	Refrigerant Scales
<b>CH-134L-80MM-34</b> <b>CH-134H-80MM-34</b>	80mm	PSI, Bar, KPA x100, °C	R32.410
<b>CH-134L-80MM-266</b> <b>CH-134H-80MM-266</b>	80mm	PSI, Bar, KPA x100, °C	R290.600.600A

Item Code	Gauge Diameter	Units	Refrigerant Scales
<b>CH-134L-80MM</b> <b>CH-134H-80MM</b>	80mm	PSI, Bar, °C KPA x100	R22.134.404.407
<b>CH-134L-80MM-410</b> <b>CH-134H-80MM-410</b>	80mm	PSI, Bar, °C KPA x100	R134.404.407.410
<b>CH-134L-80MM-1</b> <b>CH-134H-80MM-1</b>	80mm	PSI, Bar, °C & °F KPA x100	R410
<b>CH-134L-80MM-2474</b> <b>CH-134H-80MM-2474</b>	80mm	PSI, Bar, °C	R22.134.407.410



# 旋轉式塑膠蓋冷媒錶

## REFRIGERANT GAUGE - 1/8" NPT



Item Code	Gauge Diameter	Units	Refrigerant Scales
<b>RG-40-600</b> <b>RG-140-600</b>	2-3/4"	PSI, Bar, °C KPA x100	R600A

Item Code	Gauge Diameter	Units	Refrigerant Scales
<b>RG-250-R404</b> <b>RG-500-R404</b>	2-3/4"	PSI, Bar, °C KPA x100	R22.134. 404
<b>RG-250-R407A</b> <b>RG-500-R407A</b>	2-3/4"	PSI, Bar, °C	R134.404. 407



Item Code	Gauge Diameter	Units	Refrigerant Scales
<b>RG-410-500</b> <b>RG-410-800</b>	2-3/4"	PSI, Bar, °C & °F	R410
<b>RG-410-500-214</b> <b>RG-410-800-214</b>	2-3/4"	PSI, kg/cm <sup>2</sup> , °C	R22.134.410
<b>RG-410-500M</b> <b>RG-410-800M</b>	2-3/4"	MPA, °C	R404.407.410
<b>RG-410-500-2144</b> <b>RG-410-800-2144</b>	2-3/4"	PSI, Bar, °C	R22.134. 404.410

Item Code	Gauge Diameter	Units	Refrigerant Scales
<b>RG-250N</b> <b>RG-500N</b>	2-3/4"	PSI, kg/cm <sup>2</sup> , °C	R12.22.134
<b>RG-250N4</b> <b>RG-500N4</b>	2-3/4"	kg/cm <sup>2</sup> , Bar, °C	R12.22. 134.404
<b>RG-250M</b> <b>RG-500M</b>	2-3/4"	MPA, °C	R12.134



Item Code	Gauge Diameter	Units	Refrigerant Scales
<b>RG-250A</b> <b>RG-500A</b>	2-3/4"	PSI, Bar, °C	R12.22.134

Item Code	Gauge Diameter	Units	Refrigerant Scales
<b>RG-250B</b> <b>RG-500B</b>	2-3/4"	PSI, Bar, °C	R12.22.134



# 冷凍庫門安全雙把手

## DOUBLE SAFETY LATCHES & INSIDE RELEASE HANDLES

### 鋅合金凸門安全雙把手

#### DOUBLE CAM-LIFT SAFETY LATCH

▶▶▶ CH-1178-L2

Material : high pressure die-cast zinc

### 不銹鋼凸門安全雙把手

#### DOUBLE CAM-LIFT SAFETY LATCH

▶▶▶ CH-1178-LS2

Material : precision stainless steel

### 鋅合金雙凸門手拉式安全把手

#### CAM-LIFT RING SAFETY LATCH

▶▶▶ CH-1178-L3

Material : high pressure die-cast zinc

### 不銹鋼雙凸門手拉式安全把手

#### CAM-LIFT RING SAFETY LATCH

▶▶▶ CH-1178-LS3

Material : precision stainless steel

### 鋅合金平門安全雙把手

#### DOUBLE PLANE SAFETY LATCH

▶▶▶ CH-1178-P2

Material : high pressure die-cast zinc

### 不銹鋼平門安全雙把手

#### DOUBLE PLANE SAFETY LATCH

▶▶▶ CH-1178-PS2

Material : precision stainless steel

### 鋅合金雙平門手拉式安全把手

#### PLANE RING SAFETY LATCH

▶▶▶ CH-1178-P3

Material : high pressure die-cast zinc

### 不銹鋼雙平門手拉式安全把手

#### PLANE RING SAFETY LATCH

▶▶▶ CH-1178-PS3

Material : precision stainless steel



CH-1178-PS3



示意圖為不銹鋼平門雙把手



示意圖為不銹鋼平門拉把手

CH-1178-PS2

安裝示意圖



# 冷凍庫把手

## LATCH HIGH QUALITY GALVANIZED

STAINLESS STEEL MATERIAL IS OPTIONAL.

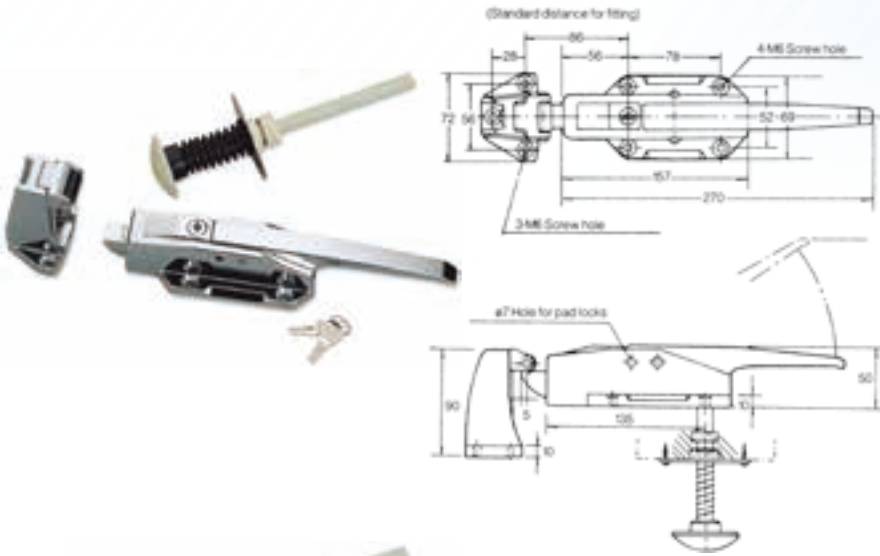

### ▶▶ CH-1178

Material : high pressure die-cast zinc.  
 Finish : highly polished chrome plated.  
 Packing : 1 body and strike per box, then 12 boxes per carton.  
 Offset : adjustable height from 45.0mm to 70.0mm.  
 Action : door of big or medium refrigerator.  
 Set include CH-1100 inside release handle.

### ▶▶ CH-1178-ST

Material : 304 stainless steel hinge & steel screw.



### ▶▶ CH-1178N

Safety handle

### ▶▶ CH-1179A    ▶▶ CH-1179B

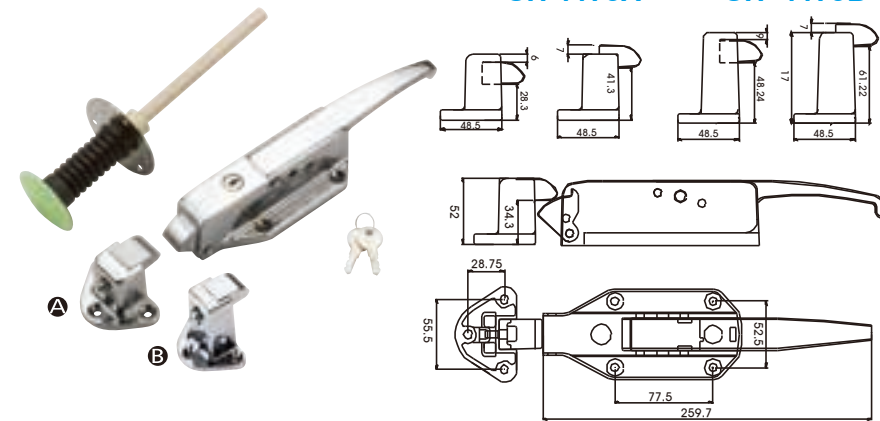

### ▶▶ CH-1179

Material : high pressure die-cast zinc.  
 Finish : highly polished chrome plated.  
 Packing : 1 body and strike per box, then 12 boxes per carton.  
 Offset : adjustable height  
 A from 28mm to 41mm.  
 B from 48mm to 61mm.  
 Action : door of big or medium refrigerator.  
 Set include CH-1100 inside release handle.

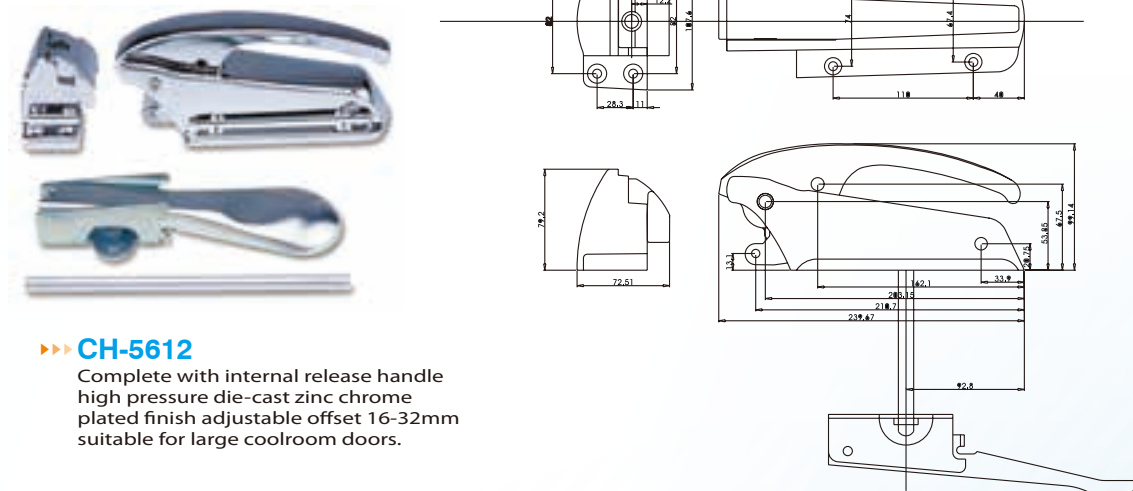

### ▶▶ CH-5612

Complete with internal release handle  
 high pressure die-cast zinc chrome plated finish adjustable offset 16-32mm suitable for large coolroom doors.

# 冷凍庫把手 & 鉸鏈

## HINGE & LATCH HIGH QUALITY GALVANIZED

STAINLESS STEEL MATERIAL IS OPTIONAL.

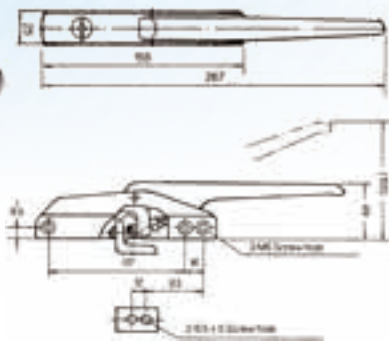

### ▶▶ CH-1200B

Material : high pressure die-cast zinc.  
 Finish : highly polished chrome plated.  
 Packing : 1 body and strike per box, then 30 boxes per carton.  
 Offset : standard strike adjustable from 18.0mm to 22.0mm.  
 Action : door of big or medium refrigerator.

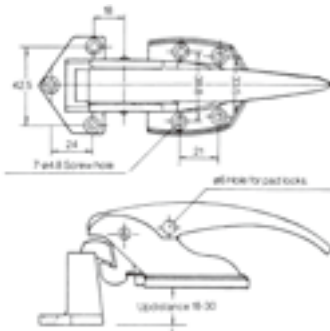

### ▶▶ CH-1300

Material : high pressure die-cast zinc.  
 Finish : highly polished chrome plated.  
 Packing : 50 pcs per carton.  
 Offset : adjustable height from 18.0mm to 32.0mm.  
 Action : door of small refrigerator.

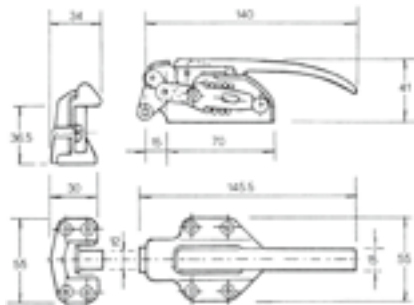

### ▶▶ CH-1400B (Brass wheel)

Material : high pressure die-cast zinc.  
 Finish : highly polished chrome plated.  
 Packing : 50 pcs per carton.  
 Offset : adjustable height from 18.0mm to 32.0mm.  
 Action : door of small refrigerator.

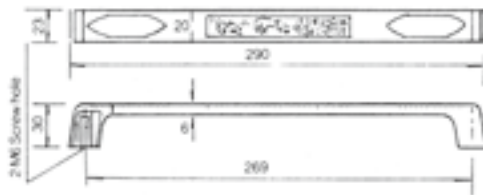

### ▶▶ CH-1500

Material : high pressure die-cast zinc.  
 Finish : highly polished chrome plated.  
 Packing : 100 pcs carton.  
 Speciality : tapped for 6.0mm screw.  
 Action : home or commercial refrigerator handle.

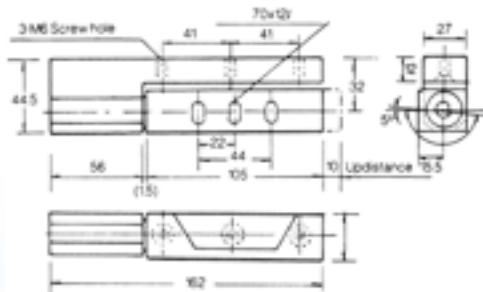

### ▶▶ CH-1132

Material : high pressure die-cast zinc.  
 Finish : highly polished chrome plated.  
 Packing : 50 pcs (25 pairs) per carton.  
 Speciality : self-closing, cam-lift hing of left or right doors, automatic close within 95° angle or stay open beyond 120° angle.  
 Action : light door of big or medium refrigerator.

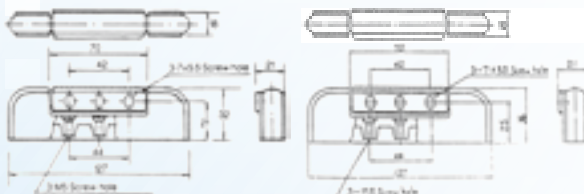

### ▶▶ CH-1332 / CH-1336

Material : high pressure die-cast zinc.  
 Finish : highly polished chrome plated.  
 Packing : 100 pcs (50 pairs) per carton.  
 Speciality : install for left or right door.  
 Action : various doors.

■1332

■1336



# ↗ 鉸鏈

## HINGE HIGH QUALITY GALVANIZED

STAINLESS STEEL MATERIAL IS OPTIONAL.

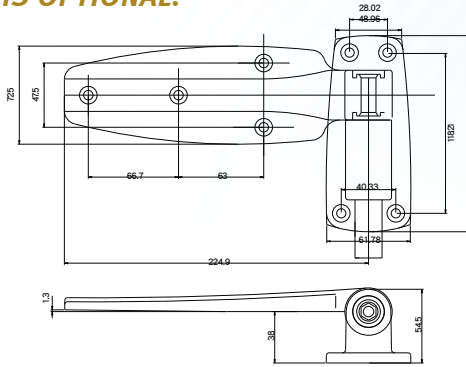

### ▶▶ CH-1238S

Material : high pressure die-cast zinc.  
 Finish : highly polished chrome plated.  
 Packing : 20 pcs (10 pairs) per carton.  
 Offset : spring-assisted, self-closing high, can be used for left or right handle door.  
 Automatic close within 120° angle or stay open beyond 120° angle 38mm height.  
 Action : door of medium or small refrigerator.

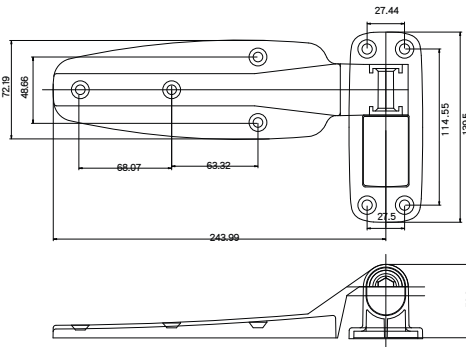

### ▶▶ CH-1230N

Material : high pressure die-cast zinc.  
 Finish : highly polished chrome plated.  
 Packing : 20 pcs (10 pairs) per carton.  
 Offset : nylon-assisted, others are same as CH-1230S.  
 Action : door of medium or small refrigerator.

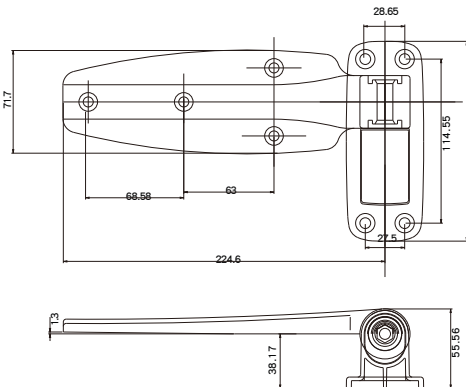

### ▶▶ CH-1238N

Material : high pressure die-cast zinc.  
 Finish : highly polished chrome plated.  
 Packing : 20 pcs (10 pairs) per carton.  
 Offset : nylon-assisted, others are same as CH-1238S.  
 Action : door of medium or small refrigerator.

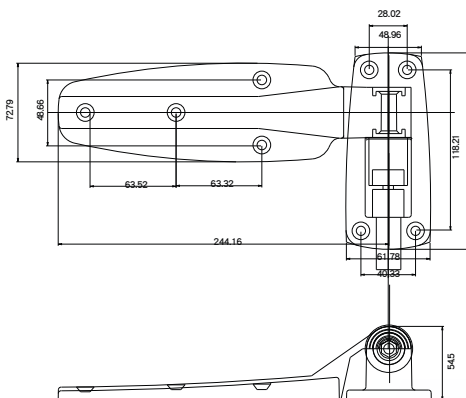

### ▶▶ CH-1230S

Material : high pressure die-cast zinc.  
 Finish : highly polished chrome plated.  
 Packing : 20 pcs (10 pairs) per carton.  
 Offset : spring-assisted, used for door is parallel with frame self-closing high can be used for left or right handle door automatic close within 120° angle or stay open beyond 120°  
 Action : door of medium or small refrigerator.

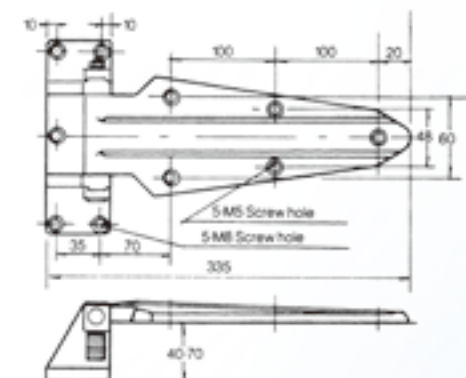

### ▶▶ CH-1470

Material : high pressure die-cast zinc.  
 Finish : highly polished chrome plated.  
 Packing : 10 pairs per carton.  
 Offset : adjustable height from 40mm to 70mm.  
 Action : door of big refrigerator.  
 Speciality : same as CH-1450.

### ▶▶ CH-1470-ST

Material : 304 stainless steel hinge & steel screw.

# 鉸鏈

## HINGE HIGH QUALITY

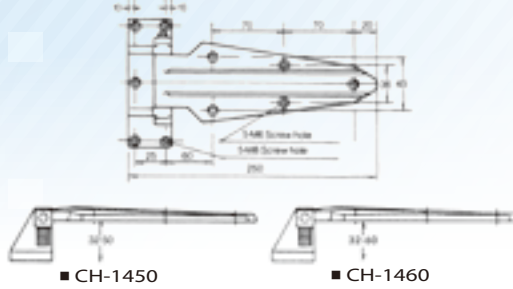
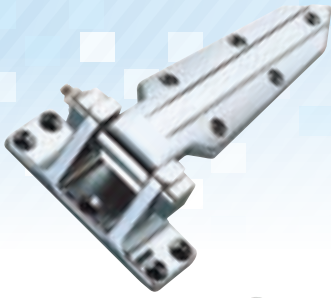

■ CH-1450

■ CH-1460

### ▶▶ CH-1450 / CH-1460

Material : high pressure die-cast zinc.  
 Finish : highly polished chrome plated.  
 Packing : 15 pairs per carton.  
 Offset : adjustable height  
 CH-1450 from 32mm to 50mm  
 CH-1460 from 32mm to 60mm  
 Action : door of medium refrigerator.  
 Speciality : can be used for left or right door.

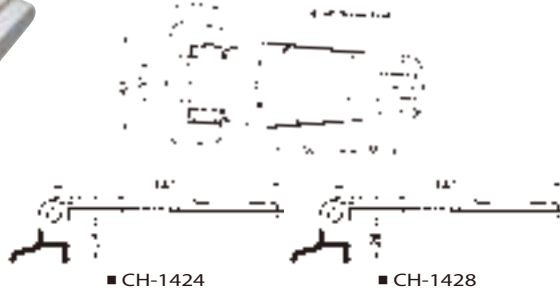
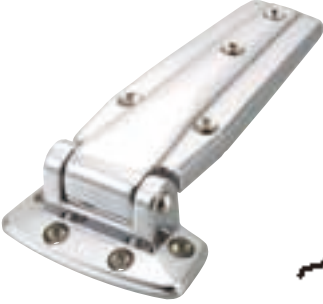

■ CH-1424

■ CH-1428

### ▶▶ CH-1424 / CH-1428

Material : high pressure die-cast zinc.  
 Finish : highly polished chrome plated.  
 Packing : 50 pcs per carton.  
 Offset : adjustable height  
 CH-1424 from 24mm  
 CH-1428 from 28mm

# 冷凍照明燈

## LAMP



### ▶▶ CH-1011

Cool room, inside lamps.  
 (220V/110V;60W/40W)

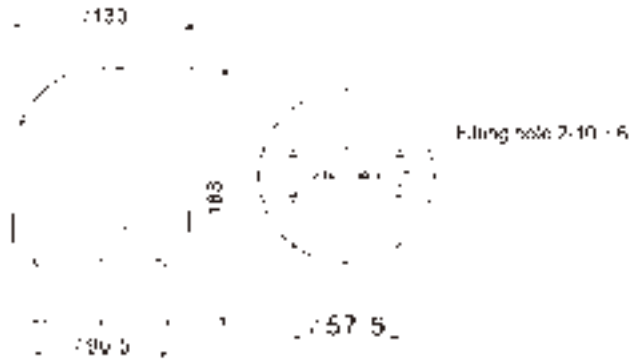

# 溫控冷凍庫壓力平衡窗

## VENTILATOR



### ▶▶ CH-1110-R-110V

(A/C 110V)

### ▶▶ CH-1110-R-220V

(A/C 220V)

#### Formula公式

$$\text{Number of Ventilator} = \frac{1.3V}{T(273+t)}$$

壓力平衡窗的數量 =

V = Volume of the room in M<sup>3</sup>  
 (房間容積M<sup>3</sup> 立方公尺)

T = Time variation in min. for 1°C  
 (溫度變化所需要的時間-分鐘)

t = Room temperature in °C,  
 273 and 1.3 are constant values  
 (房間裡的溫度°C, 273跟1.3是常值)



### ▶▶ CH-1110-S-110V

(A/C 110V)

### ▶▶ CH-1110-S-220V

(A/C 220V)

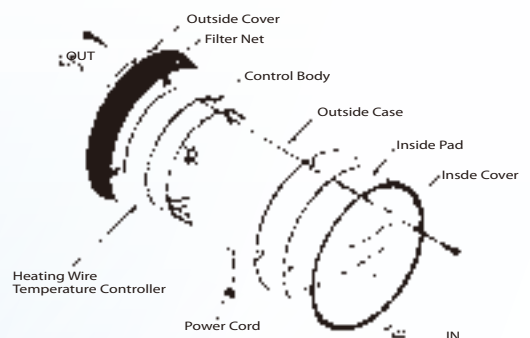
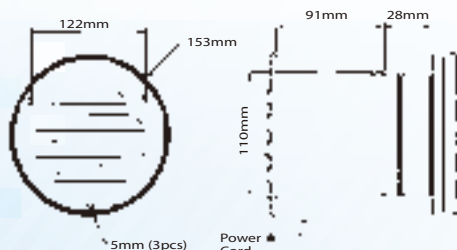

# 沖灌閥 & U型沖灌閥

## SOLDER UNION



SU-04 14" Adapter

CH-9520C valve core and VCR-04 or CT-640-04

- ▶▶▶ **SU-02**  
1/4" M. fl.x 1/8" O.D.  
(Solder union 6cm)
- ▶▶▶ **SU-02L**  
1/4" M. fl.x 1/8" O.D.  
(Solder union 10cm)
- ▶▶▶ **SU-03**  
1/4" M. fl.x 3/16" O.D.  
(Solder union 6cm)
- ▶▶▶ **SU-03L**  
1/4" M. fl.x 3/16" O.D.  
(Solder union 10cm)
- ▶▶▶ **SU-04S**  
1/4" M. fl.x 1/4" O.D.  
(Solder union 6cm)
- ▶▶▶ **SU-04L**  
1/4" M. fl.x 1/4" O.D.  
(Solder union 10cm)
- ▶▶▶ **SU-05**  
1/4" M. fl.x 5/16" O.D.  
(Solder union 6cm)
- ▶▶▶ **SU-06**  
1/4" M. fl.x 3/8" O.D.  
(Solder union 6cm)



- ▶▶▶ **SU-04U**  
1/4" M. fl.x 1/4" F. fl.
- ▶▶▶ **SU-08U**  
1/2" M. fl.x 1/2" F. fl.
- ▶▶▶ **SU-06U**  
3/8" M. fl.x 3/8" F. fl.
- ▶▶▶ **SU-10U**  
5/8" M. fl.x 5/8" F. fl.

## 視窗-鎖牙

### SIGHT GLASS FLARE TYPE



- ▶▶▶ **CT-800-04**  
1/4"
- ▶▶▶ **CT-800-06**  
3/8"
- ▶▶▶ **CT-800-08**  
1/2"
- ▶▶▶ **CT-800-10**  
5/8"
- ▶▶▶ **CT-800-12**  
3/4"

## 視窗-焊接

### SOLDER TYPE



- ▶▶▶ **CT-801-04S**  
1/4"
- ▶▶▶ **CT-801-06S**  
3/8"
- ▶▶▶ **CT-801-08S**  
1/2"
- ▶▶▶ **CT-801-10S**  
5/8"
- ▶▶▶ **CT-801-12S**  
3/4"
- ▶▶▶ **CT-801-14S**  
7/8"

## 焊銅管視窗

### SOLDER W/EXT. TUBE



- ▶▶▶ **CT-802-04**  
1/4"
- ▶▶▶ **CT-802-06**  
3/8"
- ▶▶▶ **CT-802-08**  
1/2"
- ▶▶▶ **CT-802-10**  
5/8"
- ▶▶▶ **CT-802-12**  
3/4"
- ▶▶▶ **CT-802-14**  
7/8"

## 單焊接銅管視窗

### IMALE x FEMALE TYPE



- ▶▶▶ **CT-803-04**  
1/4"
- ▶▶▶ **CT-803-06**  
3/8"
- ▶▶▶ **CT-803-08**  
1/2"
- ▶▶▶ **CT-803-10**  
5/8"
- ▶▶▶ **CT-803-12**  
3/4"

## 特殊牙規視窗

### SIGHT GLASS



- ▶▶▶ **CT-800-04 x 02 NPT**  
1/4" SAE x 1/8" NPT
- ▶▶▶ **CT-800-05 x 02 NPT**  
5/16" SAE x 1/8" NPT

## 三通銅接頭

### 3 WAY ADAPTER

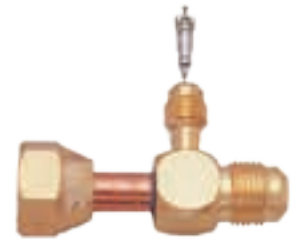

- ▶▶▶ **CH-689-04 X 04**  
1/4" M. x (1/4" M. x 1/4" F.) SAE
- ▶▶▶ **CH-689-04 X 06**  
1/4" M. x (3/8" M. x 3/8" F.) SAE
- ▶▶▶ **CH-689-04 X 08**  
1/4" M. x (1/2" M. x 1/2" F.) SAE
- ▶▶▶ **CH-689-04 X 10**  
1/4" M. x (5/8" M. x 5/8" F.) SAE

## 毛細管組

### CAPILLARY TUBE

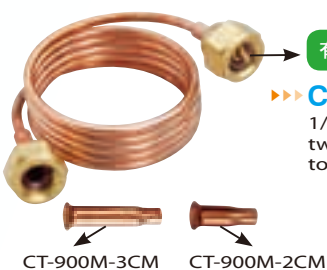

- ▶▶▶ **CT-900 DEP**  
有內蕊 depressor  
1/8" Dia. Capillary tube with two 1/4" nuts and depressor, total length 90cm



- ▶▶▶ **CT-900M CAP**  
The product is designed specially pressure indicating instruments for refrigeration industry. This capillary tube is 1/8" and two flared tube are 1/4" with two 1/4" copper nuts length is 90cm total.

\*\* Special length are also available. \*\*



# 水流開關

## FLOW SWITCH



### INTRODUCTIONS

- Used to sense the change of flow that passes the pipe lines, playing a role to protect the torrential flow.
- Can be regulated based upon different run-off of flow.
- Employ a SPDT miniature switch with large capacity, possessing the advantages of quick action to guarantee the transient of the switch.
- The housing applies the totally enclosed construction ensuring switch's normal work under any circumstances.
- Liquid temperature 0°C to 100°C

### ELECTRICAL DATA

Current (A)	Voltage (V)		
	AC 110V	AC 220V	DC 24V
Non-Induced	14	10	8
Full Load	14	10	6
Momentary	84	60	36

### SPECIFICATIONS

Model	Connection Size	Material
FSF50P-1	1"-11½ NPT	Sealed plastic case Brass connection
FSF50P-2	1/2"-14 NPT	
FSF50P-3	3/4"-14 NPT	
FSF50P-1A	1"-11½ NPT	Sealed plastic case Stainless steel connection
FSF50P-2A	1/2"-14 NPT	
FSF50P-3A	3/4"-14 NPT	

## 鎖牙帽蓋閥

### CAPPED VALVE FLARE



- ▶▶ CT-H-06  
3/8"
- ▶▶ CT-H-08  
1/2"
- ▶▶ CT-H-10  
5/8"

## 焊接帽蓋閥

### CAPPED VALVE SOLDER



- ▶▶ CT-HS-06  
3/8"
- ▶▶ CT-HS-08  
1/2"
- ▶▶ CT-HS-10  
5/8"

## 球閥

### GLOBE VALVE



- ▶▶ CH-5007  
7/8" O.D.
- ▶▶ CH-5011  
1-1/8" O.D.
- ▶▶ CH-5013  
1-3/8" O.D.
- ▶▶ CH-5015  
1-5/8" O.D.

## 錶架閥

### GAUGE VALVE



- ▶▶ GVS-04 X 02  
1/4" M x 1/8" F. NPT

## 排氣閥

### RECEIVER VALVE

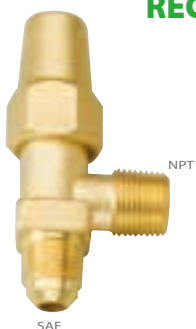

- ▶▶ RV-04NPT X 04M  
1/4" NPT x 1/4" SAE
- ▶▶ RV-06NPT X 04M  
3/8" NPT x 1/4" SAE
- ▶▶ RV-06NPT X 06M  
3/8" NPT x 3/8" SAE

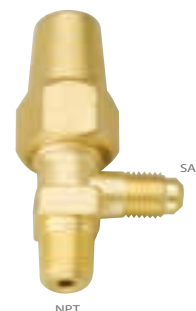

- ▶▶ RV-04 X 04  
1/4" SAE x 1/4" NPT
- ▶▶ RV-04 X 06  
1/4" SAE x 3/8" NPT
- ▶▶ RV-06 X 06  
3/8" SAE x 3/8" NPT
- ▶▶ RV-06 X 08  
3/8" SAE x 1/2" NPT
- ▶▶ RV-08 X 06  
1/2" SAE x 3/8" NPT
- ▶▶ RV-08 X 08  
1/2" SAE x 1/2" NPT

## 逆止閥

### CHECK VALVE



- ▶▶ FLARE TYPE  
W/Double Female Adapter  
CH - 6004 1/4" x 1/4"  
CH - 6005 5/16" x 5/16"
- ▶▶ SOLDER TYPE  
CH - 6004S 1/4" x 1/4"  
CH - 6005S 5/16" x 5/16"

new



- ▶▶ FLARE TYPE  
CH - 6004N 1/4" x 1/4"

## 止液閥

手動凡而

### HAND VALVE FLARE



- ▶▶ CT-D-04  
1/4"
- ▶▶ CT-D-06  
3/8"
- ▶▶ CT-D-08  
1/2"
- ▶▶ CT-D-10  
5/8"
- ▶▶ CT-D-12  
3/4"

### HAND VALVE SOLDER



- ▶▶ CT-S-04  
1/4"
- ▶▶ CT-S-06  
3/8"
- ▶▶ CT-S-08  
1/2"
- ▶▶ CT-S-10  
5/8"
- ▶▶ CT-S-12  
3/4"
- ▶▶ CT-S-14  
7/8"

## 壓縮機閥 VALVE



### COMPRESSOR VALVE

Solder-type-forged brass body, the maximum working pressure is 500PSI, Tube Size: 3/4", 7/8", 1-1/8", the parts include one asbestos pad, two bolts. Distance of hole center : 44mm

- ▶▶▶ **CH-307-7/8**  
match CH-307-1-1/8" for 3 or 5 or 7.5HP
- ▶▶▶ **CH-307-1-1/8**  
match CH-413 for 10 or 15 or 20HP  
CH-415 for 30 or 40HP



### COMPRESSOR VALVE

Solder type forged brass body. Working pressure over 500psi.

- ▶▶▶ **CH-413**  
1-3/8" O.D. Distance of hole center : 63mm
- ▶▶▶ **CH-415**  
1-5/8" O.D.

## 分離式冷氣機閥 SPLIT AIR-CONDITIONER VALVE



- ▶▶▶ **CH-602-04-1/4"**  
1/4" inlet  
1/4" flare outlet
- ▶▶▶ **CH-602-0405**  
1/4" inlet  
5/16" flare outlet

2 way valve



3 way valve  
3/8" or 1/2" or 5/8" inlet 3/8"  
or 1/2" or 5/8" flare outlet 1/4"  
charging inlet with valve core

- ▶▶▶ **CH-602-04S-1/4"**
- ▶▶▶ **CH-603-06-3/8"**
- ▶▶▶ **CH-603-0605**  
5/16" charging inlet with  
valve core
- ▶▶▶ **CH-604-08-1/2"**
- ▶▶▶ **CH-604-0805**  
5/16" charging inlet with  
valve core
- ▶▶▶ **CH-605-10-5/8"**
- ▶▶▶ **CH-605-1005**  
5/16" charging inlet with  
valve core



3 way valve  
3/4" or 7/8" inlet  
3/4" or 7/8" flare outlet 1/4"  
charging inlet with valve  
core

- ▶▶▶ **CH-606-12-3/4"**
- ▶▶▶ **CH-606-1205**  
5/16" charging inlet with  
valve core
- ▶▶▶ **CH-607-14-7/8"**
- ▶▶▶ **CH-607-1405**  
5/16" charging inlet with  
valve core

## 開罐器/針閥 CAN TAP VALVE / TOOL



### ▶▶▶ **CH-340**

Can tap valve steel body, zinc handle, clamp type fits for flat and every kind connection thread refrigerant can.



### ▶▶▶ **CH-341**

Line piercing valve fits 3/16" thru 3/8" O.D. and has 1/4" flare connection for charging hose.



### ▶▶▶ **CH-342**

Can tap valve forged brass body, strong and no leaking. Specially for R134A can 1/2" ACME female X 1/2" ACME male.



- ▶▶▶ **CH-338**  
1/4" flare outlet valve bottom female thread fitted with 12mm x 1.5 can thread.
- ▶▶▶ **CH-338J**  
1/4" flare outlet valve bottom female thread fitted with 14mm x 1.5 can thread.
- ▶▶▶ **CH-339**  
10mm flare outlet valve bottom female thread fitted with 12mm x 1.5 can thread.
- ▶▶▶ **CH-339J**  
10mm flare outlet valve bottom female thread fitted with 14mm x 1.5 can thread.

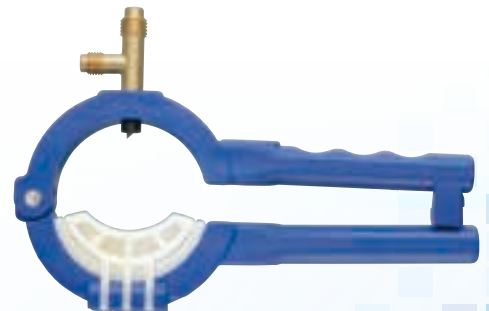

### ▶▶▶ **CH-309**

3-in-1 Can tap: R-12, R134a & oil charge cans Dual 1/4" SAE & 1/2" ACME tee fitting for both R-12 & R-134a,

**\*\* Permanently attached swiveling inserts, quick change between can types.\*\***

# 銅接頭系列

## REFRIGERATION FLARED TUBE FITTING



- WITH VALVE CORE**
- ▶▶ **CT-627-04 x 02**  
1/4" x 1/8" NPT
  - ▶▶ **CT-627-04 x 04**  
1/4" x 1/4" NPT
  - ▶▶ **CT-629-05 x 02**  
5/16" x 1/8" NPT

有關蕊



- MULTI SIZE SOLDER UNION**
- ▶▶ **CT-7000**  
for 1/8", 3/16", 1/4", 5/16", 3/8", 1/2" O.D. tubing with valve core.

有關蕊



- CHARGING FITTING**
- ▶▶ **CT-628-04**  
1/4", 1/4" flare with valve core

有關蕊



- ▶▶ **CT-682-04 x 02**  
1/4" x 1/4" x 1/8" F. NPS
- ▶▶ **CT-682-04 x 04**  
1/4" x 1/4" x 1/4" F. SAE



- ▶▶ **UT-04** -1/4"
- ▶▶ **UT-06** -3/8"
- ▶▶ **UT-08** -1/2"
- ▶▶ **UT-10** -5/8"
- ▶▶ **UT-12** -3/4"



- ▶▶ **CT-672-04 x 02**  
1/4" x 1/4" x 1/8" NPT
- ▶▶ **CT-672-04 x 04**  
1/4" x 1/4" x 1/4" NPT

# 彎型接頭

## ELBOW



- UNION ELBOW**
- ▶▶ **UE-04** 1/4" x 1/4"
  - ▶▶ **UE-06** 3/8" x 3/8"
  - ▶▶ **UE-08** 1/2" x 1/2"
  - ▶▶ **UE-10** 5/8" x 5/8"
  - ▶▶ **UE-12** 3/4" x 3/4"



- MALE ELBOW**
- ▶▶ **ME-04 x 02** 1/4" flare x 1/8" NPT
  - ▶▶ **ME-04 x 04** 1/4" flare x 1/4" NPT
  - ▶▶ **ME-06 x 06** 3/8" flare x 3/8" NPT
  - ▶▶ **ME-08 x 08** 1/2" flare x 1/2" NPT



- FEMALE SWIVEL ELBOW**
- ▶▶ **CT-679-06 x 06** 3/8" x 3/8"
  - ▶▶ **CT-679-08 x 08** 1/2" x 1/2"
  - ▶▶ **CT-679-10 x 10** 5/8" x 5/8"



- ADAPTER 90° SWIVEL ELBOW**
- ▶▶ **CT-10** 1/4" male x 1/4" female
  - ▶▶ **CT-11** 1/4" male x 3/16" female
  - ▶▶ **CT-12** 1/4" male x 1/8" female
  - ▶▶ **CT-13** 5/16" male x 5/16" female
  - ▶▶ **CT-10-05F** 1/4" male x 5/16" female

# 活動 & 一般轉接頭

## CYLINDER ADAPTER SET



## 活動 & 一般轉接頭組

### ▶▶ AD001

1	2	3	4
<b>CA-04*08</b> For QC-L & QC-H 1/4" M.F. x M14x1.5 w/o-ring	<b>CA-04*05CV</b> 5/16" M.F. w/valve core x 1/4" F.F.	<b>SCA-04M*05F</b> 1/4" M.F. x 5/16" F.F.	<b>CA-04*05</b> 1/4" M.F. x 1/2" ACME F.F.
2PCS	2PCS	2PCS	2PCS
5	6	7	8
<b>CH-146-1</b> For QC-LM10 10mm M.F. x M14x1.5 w/o-ring	<b>CA-05*04CV</b> 1/4" M.F. w/valve core x 5/16" F.F.	<b>SCA-05M*04F</b> 5/16" M.F. x 1/4" F.F.	<b>CA-05*04</b> 1/2" ACME M.F. x 1/4" F.F.
2PCS	2PCS	2PCS	2PCS
9	10	11	12
<b>CH-146-3</b> For QC-HM12 12mm M.F. x M14x1.5 w/o-ring	<b>R-04*05</b> 1/4" M.F. x 5/16" F.F.	<b>R-05*04</b> 5/16" M.F. x 1/4" F.F.	<b>CA-04*12MM</b> 1/4" M.F. x M12x1.5 w/o-ring for QC-L1234, H1234
2PCS	2PCS	2PCS	2PCS

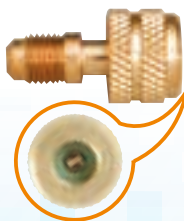

- ▶▶ **SCA-04M x 05F**  
1/4" M.F. x 5/16" F.F. (1/2-20 UNF)
- ▶▶ **SCA-05M x 04F**  
5/16" M.F. (1/2-20 UNF) x 1/4" F.F.



- ▶▶ **CA-04 x 05**  
1/4" flare male x 1/2" ACME female



- ▶▶ **CA-05 x 04**  
1/2" ACME male x 1/4" flare female

- ▶▶ **CA-04 x 05LH**  
1/4" flare male x 1/2" ACME LH

- ▶▶ **CA-05LH x 04**  
1/2" ACME LH x 1/4" flare female



- ▶▶ **CA-04 x 08**  
1/4" M.F. (7/16-20 UNF) x M14 x 1.5 with o-ring
- ▶▶ **CA-06 x 08**  
3/8" M.F. (5/8-18 UNF) x M14 x 1.5 with o-ring
- ▶▶ **CH-146**  
Changeable adapter 4pcs/card

Switch to R134A hose thread

1pcs 10mm x 1.5 x 14mm x 1.5

1pcs 12mm x 1.75 x 14mm x 1.5

Switch to R12 hose thread

2pcs 1/4M.F. X 14mm X 1.5



- ▶▶ **CA-03 x 12**  
10mm M.F. x 3/4" F.F. (1-1/32-14 UNF) thread R134A use.
- ▶▶ **CA-04 x 10**  
1/4" M.F. x 5/8" F.F. (7/8-14 UNF)
- ▶▶ **CA-04 x 12**  
1/4" M.F. x 3/4" F.F. (1-1/32-14 UNF) thread R12 use.
- ▶▶ **CA-05 x 12**  
1/2" ACME M.F. x 3/4" F.F. (1-1/32-14 UNF) thread R134A use.
- ▶▶ **CA-08 x 12**  
1/2" M.F. x 3/4" F.F. (1-1/32-14 UNF) thread R12 use.



# 銅頭系列 BRASS NUT



## LONG NUT

Item NO.	Tube O.D.IN
SN1-04	1/4"
SN1-05	5/16"
SN1-06	3/8"
SN1-08	1/2"
SN1-10	5/8"
SN1-12	3/4"



## SHORT NUT

Item NO.	Tube O.D.IN
SN2-04	1/4"
SN2-05	5/16"
SN2-06	3/8"
SN2-08	1/2"
SN2-10	5/8"



## REDUCING NUT

Item NO.	Outlet O.D.IN	Tube O.D.IN / W.
RN-03 X 04	3/16"	x 1/4" / 16H
RN-04 X 06	1/4"	x 3/8" / 21H
RN-06 X 08	3/8"	x 1/2" / 25H
RN-08 X 10	1/2"	x 5/8" / 27H
RN-10 X 12	5/8"	x 3/4" / 32H



## STRONG REDUCING NUT

Item NO.	Outlet O.D.IN	Tube O.D.IN / W.
RNN-03 X 04	3/16"	x 1/4" / 17H
RNN-04 X 06	1/4"	x 3/8" / 22H
RNN-06 X 08	3/8"	x 1/2" / 27H
RNN-08 X 10	1/2"	x 5/8" / 29H



## STRONG SHORT NUT

Item NO.	Tube O.D.IN / W.
N-04	1/4" / 17H
N-06	3/8" / 22H
N-08	1/2" / 27H
NS-08	1/2" / 26H
N-10	5/8" / 29H
SN2-12	3/4" / 32H



## FORGED NUT

Item NO.	Tube O.D.IN
N-04-F	1/4"
N-06-F	3/8"
N-08-F	1/2"
N-10-F	5/8"
N-12	3/4"
N-14	7/8"



## CAP NUT

Item NO.	Tube O.D.IN
CN-04	1/4"
CN-05	5/16"
CN-06	3/8"
CN-08	1/2"
CN-10	5/8"
CN-12	3/4"



## PLUG

Item NO.	Tube O.D.IN
P-04	1/4"
P-05	5/16"
P-06	3/8"
P-08	1/2"
P-10	5/8"
P-12	3/4"



## FEMALE CONNECTOR

Item NO.	Tube O.D.IN
FC-04 x 02	1/4" x 1/8" NPS
FC-04 x 04	1/4" x 1/4" NPS
FC-04 x 06	1/4" x 3/8" NPS
FC-02 NPT x 06PS	1/8" NPT x 3/8" PS-19



## REDUCING UNION

Item NO.	Tube O.D.IN
RU-04 x 10	1/4" x 5/8"
RU-05 x 04	5/16" x 1/4"
RU-06 x 04	3/8" x 1/4"
RU-06 x 05	3/8" x 5/16"
RU-08 x 04	1/2" x 1/4"
RU-08 x 06	1/2" x 3/8"
RU-10 x 06	5/8" x 3/8"
RU-10 x 08	5/8" x 1/2"
RU-12 x 08	3/4" x 1/2"
RU-12 x 10	3/4" x 5/8"



## MALE CONNECTOR

Item NO.	Tube O.D.IN
MC-04 x 02	1/4" x 1/8" NPT
MC-04 x 04	1/4" x 1/4" NPT
MC-04 x 06	1/4" x 3/8" NPT
MC-04 x 08	1/4" x 1/2" NPT
MC-05 x 04	5/16" x 1/4" NPT
MC-06 x 04	3/8" x 1/4" NPT
MC-06 x 06	3/8" x 3/8" NPT
MC-06 x 08	3/8" x 1/2" NPT
MC-08 x 06	1/2" x 3/8" NPT
MC-08 x 08	1/2" x 1/2" NPT
MC-08 x 12	1/2" x 3/4" NPT
MC-10 x 06	5/8" x 3/8" NPT
MC-10 x 08	5/8" x 1/2" NPT
MC-10 x 12	5/8" x 3/4" NPT
MC-12 x 12	3/4" x 3/4" NPT



## REDUCER

Item NO.	Tube O.D.IN
R-04 x 05	1/4" x 5/16"
R-04 x 06	1/4" x 3/8"
R-04 x 08	1/4" x 1/2"
R-05 x 04	5/16" x 1/4"
R-06 x 04	3/8" x 1/4"
R-06 x 05	3/8" x 5/16"
R-06 x 08	3/8" x 1/2"
R-06 x 10	3/8" x 5/8"
R-08 x 04	1/2" x 1/4"
R-08 x 06	1/2" x 3/8"
R-08 x 10	1/2" x 5/8"
R-10 x 06	5/8" x 3/8"
R-10 x 08	5/8" x 1/2"
R-10 x 12	5/8" x 3/4"
R-12 x 08	3/4" x 1/2"
R-12 x 10	3/4" x 5/8"



## FLARE TO SOLDER UNION

Item NO.	Tube O.D.IN	Item NO.	Tube O.D.IN
FSU-04 x 04	1/4" x 1/4"	FSU-08 x 10	1/2" x 5/8"
FSU-04 x 06	1/4" x 3/8"	FSU-10 x 06	5/8" x 3/8"
FSU-06 x 04	3/8" x 1/4"	FSU-10 x 08	5/8" x 1/2"
FSU-06 x 06	3/8" x 3/8"	FSU-10 x 10	5/8" x 5/8"
FSU-06 x 08	3/8" x 1/2"	FSU-12 x 08	3/4" x 1/2"
FSU-08 x 06	1/2" x 3/8"	FSU-12 x 10	3/4" x 5/8"
FSU-08 x 08	1/2" x 1/2"	FSU-12 x 12	3/4" x 3/4"



## UNION

Item NO.	Tube O.D.IN
U-04	1/4"
U-05	5/16"
U-06	3/8"
U-08	1/2"
U-10	5/8"
U-12	3/4"



## WRENCH CAP

Item NO.	Tube O.D.IN
VCR-04	1/4"
VCR-05	5/16"



## FLARE CAP

Item NO.	Tube O.D.IN
CT-640-04	1/4"
CT-640-05	5/16"
CT-640-08	1/2"

## 紅銅帽 COPPER SEAL CAP



- ▶▶ CS-04 -1/4"
- ▶▶ CS-06 -3/8"
- ▶▶ CS-08 -1/2"
- ▶▶ CS-10 -5/8"
- ▶▶ CS-12 -3/4"
- ▶▶ CS-14 -7/8"



- ▶▶ CS-04S -1/4"
- ▶▶ CS-06S -3/8"
- ▶▶ CS-08S -1/2"
- ▶▶ CS-10S -5/8"
- ▶▶ CS-12S -3/4"
- ▶▶ CS-14S -7/8"

## 安全栓 SAFETY PLUG



可溶栓

The filled tin alloy will be fusible when system temperature is higher than 76°C / 168°F or 100°C / 212°F. Recommend for safety factor.

- ▶▶ CH-02 1/8" NPT
- ▶▶ CH-04 1/4" NPT
- ▶▶ CH-06 3/8" NPT-18NPT

## 烤箱溫度計 OVEN THERMOMETER



- ▶▶ OT-221N  
50~300°C  
100~600°F

## 冰箱溫度計 REFRIGERATOR / FREEZER THERMOMETER



- ▶▶ RT-221  
2-1/2" stainless steel case.  
Temperature range : -30/30°C & -20/80°F

## 口袋型 & 電子溫度計 POCKET & DIGITAL THERMOMETER



- ▶▶ CH-1415  
-58~482°F, -50~250°C Switchable  
1-1/4" Dia, 5" S.S stem  
with pocket clip case.  
2 push button (ON/OFF)  
Battery power capacity display  
Normal mode is 10 seconds per display  
1 second update when hold  
button of "ON"



- ▶▶ CH-143  
1-3/4" DIAL, 5" S.S.  
Stem with pocket clip case.  
Temperature range:  
Dual seale :  
-40/70°C & -40/160°F or,  
-10/110°C & 0/220°F



- ▶▶ CH-1005C  
1" dial, 5" S.S.  
Stem with pocket clip case.  
Temperature range:  
-40/70°C, -10/110°C,  
0/300°C, -40/100°F,  
0/220°F, -20/110°C



- ▶▶ CH-1415P  
-50~+150°C  
-58~+302°F

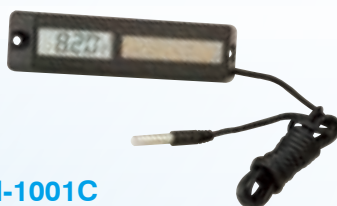

- ▶▶ CH-1001C  
-50°C~70°C, -40°C~70°C  
48" Wire sensor thermometer works  
by solar power and with a easy replace  
battery to provide power once light  
level decreased.

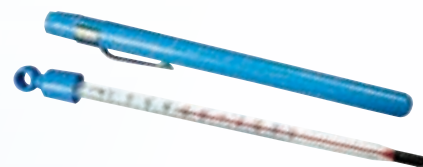

## 玻璃溫度計 GLASS THERMOMETER

- ▶▶ GT-100  
Red spirits filled, ABS case with pocket clip  
Temperature range : -40/70°C or -40°/160°F

# 紅外線溫度計

## INFRARED THERMOMETER



### TM-301 INTRODUCTION

- Pull and hold trigger (laser pointer is on as default setting) to turn on, LCD display reading & battery icon. Release the trigger and the reading will hold for approx 10 sec.
- Locating a hot spot : Aim the thermometer outside the area of interest.

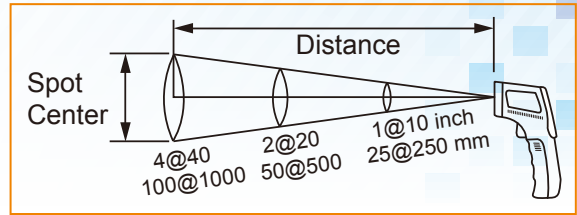

Scan across the area in an up and down motion until the hot spot is located while holding the activation trigger. The thermometer will continue to read the surface temperature while the activation trigger is pressed.

### SPECIFICATIONS

- Temperature range: -30°C ~ 530°C (-22°F ~ 986°F)
- Accuracy : ±3°C (± 5°F) (-30°C~20°C / -22°F~68°F)
- Spectral Response : 5 ~ 14μ
- Resolution : 0.2°C / 0.5°F
- Laser power : ≤ 1mW
- Weight : ≥ 150g (without battery)
- Battery life : 12 hours
- Ambient operating range : 0~40°C (32°F~104°F) ≤ 80%RH(noncondensing)
- Storage temp / humidity : -10°C ~ 60°F (14°F ~ 140°F) ≤ 70%RH
- Repeatability : ±2% or ± 2°C (± 3°F)
- Response time : 500ms@95%
- Emissivity : 0.95
- Power : 9V battery, 006Por IEC 6F22
- Auto power time : ≤ 10 sec
- Size : 166x95x33mm. (LxWxH)
- D:S : 10:1

# 數位溫度錶

## DUAL INPUT K / J TYPE THERMOMETER



Protection Holster (optional accessory)



### TM-82N

#### POWER SUPPLY

- Battery type : 9V battery NEDA 1604, IEC 6F22, JIS 006P x1 PCS.

#### SPECIFICATIONS

- Dimension : 130x 56x38mm. (LxWxH)
- Weight : About 170g. (including battery)

Temperature unit	°C or °F optional
Temperature range	K type : -200 °C~1370 °C (-328 °F~2498 °F) J type : -200 °C~1050 °C (-328 °F~1922 °F)
Display resolution	0.1 °C(0.2 °F)
Accuracy	±(0.05%+0.7 °C) ±(0.05%+1.4 °F)
Input protection	Maximum voltage of temperature input is 24 DC or AC
Temperature coefficient	0.01% of reading +0.03 °C per °C (0.01% of reading +0.06 °F per °F) when circumstance out of the specified range of 18 °C~28 °C (64 °F~ 82 °F)

### YF-160A K Type thermometer

#### DISPLAY

- 3 1/2 digits LCD with maximum reading of 1999.
- Low battery indication: " "
- Polarity indication : automatic polarity, "-" display for negative input.

#### FUNCTIONS

- K type thermocouple with high accuracy range of -50°C ~ 1300°C (-58°F ~ 1999°F)
- Alternative measurement by °C or °F
- Function keys: ON/OFF, data hold, °C, °F 0.1°, 1.0°
- Suitable for electric engineering, freezing, air conditioning, food processing fields as well as surface temperature, metal, steel, electricity, chemical, ship building, synthetic resin process and metal heat process or other temperature control/management fields.

#### SPECIFICATIONS

Accuracy: ± (...% rdg + ...°C) at 23°C ± 5°C, below 80% RH.

	Test Range	Resolution	Accuracy
°C	-50°C ~ 1300°C	0.1°C	-50°C ~ 0°C : ±(0.5%+1°C)
			0°C ~ 199.9°C : ±(0.3%+1°C)
		1°C	-50°C ~ 300°C : ±(0.5%+1°C)
			301°C ~ 1000°C : ±(0.3%+1°C) 1001°C ~ 1300°C : ±(0.5%+1°C)
°F	-58°F ~ 1999°F	0.1°F	-58°F ~ 1999°F : ±(0.3%+2°F)
		1°F	-58°F ~ 1999°F : ±(0.3%+2°F)

The tolerance of temp.probe excluded.

\*\* Max. Input voltage for thermocouple : DC60V, AC24V\*\*





# 溫濕度記錄器

## USB TEMPERATURE / HUMIDITY DATALOGGER



patent pending



### TM-305U

#### INTRODUCTIONS

- The data is directly transferred to computer via USB cable, the docking station is not required.
- Water Resistant IP 65.
- Hi-Low set-up alarm.
- USB interface for set-up and data download.
- Fast USB download speed-download 50,000 records in less than 10 seconds.

#### SPECIFICATIONS

- Humidity sensor type : capacitive
- Sensor type : NTC
- Channel(s) : 2
- Range : -40°C to +85.0°C / -40°F to +185.0°F
- Accuracy : 0.6°C (1.2°F) from -20~50°C. (-4 to 122°F)  
1.0°C (1.8°F) all other rangers.
- Range : 1-99% RH.
- Accuracy : ±3.0% RH (20~80%RH)  
±5.0% (<20%, >80%RH)
- Interface : USB
- Datalogger memory : 50,000 records.
- Dimension : 83x60x24mm (LxWxH)



### 2040

#### SPECIFICATIONS

- Measurement range : -50 ~ +70°C & -58 ~ +158°F
- Resolution : 0.1
- Accuracy : ±1°C
- Panel mounting
- Unit size : 48mm X 28.6mm X 14mm
- Battery : 1 X 1.5V "G10" size or equivalent
- Sensor probe : internal sensor
- ABS Housing color : white

# K型熱電偶感溫棒

## K TYPE THERMOCOUPLE



Item	TP-01	TP-02	TP-03	TP-04
Thermocouple Material	Chromel-alumel alloyed the rmocouple(NI-Cr vs NI-Al)			
Contact Type	Insulation Type	Ground Type	Exposnd Type	Ground Type
Accuracy Classification	JIS C 1602 classification 0.75			
Sheath Size(mm)	3.2 Ø x 150	10 Ø x 150	Bead	15 Ø x 100
Max. Temperature	1292 °F / 700 °C		392 °F / 200 °C	752 °F / 400 °C
Min. Temperature	-58 °F / -50 °C			
Compensating Lead-Wire	(-20~90°C)1M approx.		1M approx.	(-20~90°C)1M approx.
Handhold	Max. allowable / heat 150 °C / Size: 12 Ø x 100mm		Max. allowable / heat 150 °C / Size: 12 Ø x 90mm	
Application	Available for liquid or gel	Available for front or plate	Available for complex or any place hard to enter	Available for precise surface

**380/382 REFRIGERANT LEAK DETECTOR**

**FEATURES**

- Air Sucking System for faster response and higher sensitivity. (382)
- Refrigerant Leakage-Detector is the perfect tool for maintaining the air-condition or a cooling system with compressor and refrigerant.
- This unit used newly developed semi-conductor sensor which is extremely sensitive to variety of general used refrigerant.
- Microprocessor Control with advanced digital signal processing.

**SPECIFICATIONS**

- High-low leak sensitivity selector. (380).
- 3 levels of sensitivity. (382)
- 7 LED tri-colored visual leak level indicator.
- Variable intensity audible alarm.
- Ambient concentration reset.
- 15.5" (40CM) flexible stainless probe.
- Detection of R-134a, R-404A, R-410A, R-407C, R-22, R-502, R600A ... refrigerants gas.
- Sensitivity as small 6gr/year (380) ; 3gr/year (382).
- Accordance with SAE J1627, CE design.
- Low battery indication.
- Reference leak source included.
- Hand carrying case included.
- Warm-up time : 45 seconds. (382)
- Operating temperature : 0 to 40°C (32 to 104°F)
- Power source : 4AA size alkaline batteries.
- Battery life : approx. 40hrs (380)
- AC Adapter : @3.3V 0.5A (382)

**DIMENSION**

- Size : 217X66X56mm (LxWxH)
- Weight : 400g (with battery).



DC 5V Jack (382)

**388 IR REFRIGERANT LEAK DETECTOR**

**FEATURES**

Refrigerant Leakage Detector is the perfect tool for maintaining the air-condition or a cooling system with compressor and Refrigerant. This unit uses a newly developed infrared gas sensor which is extremely sensitive to variety of general used Refrigerant.

**SPECIFICATIONS**

- Microprocessor Control with advanced digital signal processing.
- Multi color visual display.
- High-median-Low leak sensitivity selector.
- Low battery indication
- Infrared gas sensor.
- Detection of R-134a, R-410A, R-407C, R22, R32, R1234yf... Freon gas.
- Carrying case included.
- 15.5" (40cm) flexible stainless probe.
- Ambient concentration reset.
- Peak function - find leaks in noisy environments.
- Mute function.
- Auto-matic zero and background compensation.
- Warm-up Time: 45 Seconds.
- Operating Temperature: 0 to 40°C (32 to 104 °F)
- Dimension: 254 x 71 x 54mm
- Weight: 416g (with batteries)
- Power Usage: 3.7vdc rechargeable lithium Batteries.
- Battery Life: Approx. 10hrs
- AC Adapter: @5V 1A



DC 5V Jack (388)

# 風速計

## AIR VELOCITY METER



### TM-740

#### FEATURES

- Dual LCD display :  
The maximum reading on the primary display is 9999.
- The maximum reading on secondary display is 999.
- Low battery indication.

#### FUNCTIONS

- Dimension : 145\*48\*23mm (L\*W\*H)
- Power : 2 battery 1.5V AAA.
- High sensitivity of 0.4m/s.
- Auto power off with disable function.
- Weight : 80g.
- 30mm 6 plastic vane.
- Max/ Min / Avg and data hold.

#### TEMPERATURE

Unit	Range	Resolution	Accuracy
°C	-20~50	0.1	±1°C
°F	-4~122	0.1	±1.8°F

Unit	Range	Resolution	Accuracy
m/s	0.4~25	0.1	±2%+0.2
Km/hr(kph)	1.5~90	0.1	±2%+0.8
mph	0.9~55	0.1	±2%+0.4
Knots(kts)	0.8~48	0.1	±2%+0.4
ft/min(fpm)	79~4921	1	±2%+40

### TM-411 ~ 414

45mm 4 plastics vane.



### TM-402~404 & TM-411~414

#### FEATURES

- High sensitivity of 0.4m/s.
- Max/MIN/AVG and data hold.
- Low battery indication.
- Memory recall function.
- Absolute pressure sensor.
- Sample rate : one time per second.
- Air flow calculate function.
- Auto power off with disable function.
- Datalogging capacity : 99 records.
- Backlight function.
- Humidity Sensor.

#### FUNCTIONS

Model	Probe	99 Record	Flow	Temp.	Humidity	Pressure
TM-411	vane-01	●	●	●	●	●
TM-402	Pr401T	●	●	●	●	●
TM-412	vane-02	●	●	●	●	●
TM-403	Pr401H	●	●	●	●	●
TM-413	vane-03	●	●	●	●	●
TM-404	Pr401H	●	●	●	●	●
TM-414	vane-03	●	●	●	●	●

Protection Holster(optional accessory)

### TM-402 ~ 404

30mm 6 plastics vane.



#### AIR FLOW (VOLUME) CALCULATE

Unit	Ranges	Resolution	Accuracy
CMM	0~9999	1	—
CFM	0~9999	1	—

#### TEMPERATURE MEASUREMENT

Unit	Ranges	Ranges	Resolution	Accuracy
°C	-20 ~ 60	-20 ~ 50	0.1	± 1°C
°F	-4 ~ 140	-4 ~ 122	0.1	± 1.8°F

#### HUMIDITY MEASUREMENT

Unit	Ranges	Resolution	Accuracy
%RH	20 ~ 80	0.1	± 3.5%RH
%RH	<20 ~ >80	0.1	± 5%RH

#### ABSOLUTE PRESSURE

Unit	Ranges	Resolution	Accuracy
hPa	350 ~ 1100	0.1	±2h Pa
mmHg	263 ~ 825	0.1	±1.5mm Hg
inHg	10.3 ~ 32	0.1	± 0.1

#### AIR SPEED MEASUREMENT

Unit	Ranges (TM-401~TM-404)	Ranges (TM-411~TM-414)	Resolution	Accuracy
m/s	0.4 ~ 25	0.4 ~ 45	0.1	± 2%+0.2
Km/hr	1.5 ~ 90	1.5 ~ 160	0.1	± 2%+0.8
mph	0.9 ~ 55	0.9 ~ 100	0.1	± 2%+0.4
knots	0.8 ~ 48	0.8 ~ 88	0.1	± 2%+0.4
ft/min	79 ~ 4921	79 ~ 8800	1	± 2%+40
Beaufort	1 ~ 10	1 ~ 12	1	—

Protection Holster(optional accessory)



# 自動換檔數位電錶

## MULTIMETER TM-8X



	TM-81	TM-82	TM-86	TM-87	TM-88
Overvoltage Category	CAT IV 600V CAT III 1000V	CAT IV 600V CAT III 1000V	CAT IV 600V CAT III 1000V	CAT IV 600V CAT III 1000V	CAT IV 600V CAT III 1000V
Trms	—	—	—	V	V
LCD	1999 counts	1999 counts	3999 counts	3999 counts	3999 counts
Sampling rate	2.5/s	2.5/s	2.5/s	2.5/s	2.5/s
Backlit	—	YES	YES	YES	YES
Bargraph	—	—	—	YES	YES
Auto power off	V	V	V	V	V
DC Voltage	0.1 mV~ 600V(0.8%+1)	0.1mV~ 600V(0.8%+1)	0.1 mV~ 600V(0.8%+2)	0.1mV~1000V (0.5%+2)	0.1mV~1000V (0.5%+2)
AC Voltage	0.001V~ 600V(1.5%+3)	0.001V~ 600V(1.5%+3)	0.001V~ 600V(0.8%+3)	0.1mV~750V(1.3%+5)	0.1mV~750V(1.3%+5)
DC Current	—	—	0.01A ~10A(1.2%+3)	0.1uA~10A(1.0%+3)	0.1uA~10A(1.0%+3)
AC Current	—	—	0.01A ~10A(1.2%+3)	0.1uA~10A(1.5%+5)	0.1uA~10A(1.5%+5)
Resistance	200Ω, 2k, 20k, 200k, 2M, 20MΩ	200Ω, 2k, 20k, 200k, 2M, 20MΩ	400Ω, 4k, 40k, 400k, 4M, 40MΩ	400Ω, 4k, 40k, 400k, 4M, 40MΩ	400Ω, 4k, 40k, 400k, 4M, 40MΩ
Accuracy	±(1.0% + 3)	±(1.0% + 3)	±(1.0% + 2)	±(1.0% + 2)	±(1.0% + 2)
Protection	600Vrms	600Vrms	600Vrms	1000Vrms	1000Vrms
Continuity Buzzer	YES	YES	YES	YES	YES
Diode Test	YES (1.5V)	YES	YES	YES	YES
Frequency	—	—	0.01Hz~99.99KHz	1Hz~100KHz	—
Duty Cycle	—	—	20 - 80 %	—	—
Accuracy	—	—	±(1.0%+5)	—	—
Capacitance	—	—	5n,50n,500n,5u, 50u,100uF	4n,40n,400n,4u,40u, 400u,4m,40mF	4n,40n,400n,4u,40u, 400u,4m,40mF
Accuracy	—	—	±(3%+5)	±(1%+5)	±(1%+5)
Temperature	—	-40~800°C -40°F~1382°F	—	—	-40~800°C -40°F~1382°F
Accuracy	—	°C (±2%,.3) °F (±296.5)	—	—	°C (±2%+3) °F (±2%+5)
Range hold	V	V	V	V	V
Data hold	V	V	V	V	V
Max	V	V	—	Max/Min	Max/Min
Peak hold	—	—	—	V	V
REL	—	—	V	V	V
Accessories: -Carrying case, test leads, manual, battery	•	• T10 Temp adapter	•	•	• T10 Temp adapter

\*\* Top and Bottom shell are double injection(ABS+TPR).\*\*

## AC / DC 數位鉤錶 AC CLAMP METER



### TM-1016

#### 400A HVAC AUTORANGING AC CLAMP METER

- 3 3/4 digits LCD with backlit and analog bargraph.
- Test range : ACA/uA, DCA/uA, ACV, DCV,  $\Omega$ , Continuity, Capacitance and Temperature.
- Use the test leads to measure the ACuA and DCuA.
- Double injection outer case.

#### FUNCTIONS

- Continuity buzzer (<40).
- Low battery indication.
- Auto power off (30 minutes).
- R-H : range hold.
- Dimension : 205 x64 x39 mm.(LxWxH)
- Weight : 280g. (Including battery)
- Select : selection button for the composite functions of ACuA / DCuA, ACV / DCV and  $\Omega$  / Continuity.
- Overload indication.
- Auto range.
- D-H : data hold.
- Power supply :2 batteries 1.5V AAA type.

Max measuring current	400A
Display counts	4000 Count Backlit LCD
Max conductor size	30mm (11.8")
AC Current	0.1~4000uA/0.01A~400A $\pm$ (2.0% +10)
DC Current	0.1~4000uA $\pm$ (1.0% +2)
AC Voltage	1mV~600V $\pm$ (1.0% +3)
DC Voltage	1mV~600V $\pm$ (0.8% +2)
Resistance	0.1 $\Omega$ ~40M $\Omega$ $\pm$ (0.8% +2)
Temperature(K-Type)	-50 $^{\circ}$ C~1200 $^{\circ}$ C and 158 $^{\circ}$ F~1999 $^{\circ}$ F

## AC / DC 數位鉤錶 CLAMP METER



### TM-13E / TM-13R

#### 400A AUTORANGING AC/DC CLAMP METER

- 3-3/4 digits LCD with maximum reading 4000
- Test range : ACA, DCA, ACV, DCV,  $\Omega$ , continuity.

#### FUNCTIONS

- True rms (TM-13R)
- Overload indication.
- Auto power off (30 minutes).
- Range hold.
- Power supply.
- Continuity buzzer (<40).
- Low battery indication.
- Data hold.
- Zero.

#### DIMENSION

- Size : 195X64X30mm (LxWxH)
- Weight : 245g.

#### SPECIFICATIONS

Max measuring current	400A
Display counts	4000
Max conductor size	30 mm
AC Current	10mA ~ 400A $\pm$ (2.0%+10)
DC Current	10mA ~ 400A $\pm$ (2.0%+10)
AC Voltage	0.1mV ~ 600V $\pm$ (1.0%+3)
DC Voltage	0.1mV ~ 600V $\pm$ (0.8%+2)
Resistance	Yes (<40 $\Omega$ )



### TM-16E

#### 600A AUTORANGING AC CLAMP METER

- 3-1/2 digits LCD with maximum reading 2000
- Test range : ACA, ACV, DCV,  $\Omega$ , continuity, diode.

#### FUNCTIONS

- Continuity buzzer (<25  $\Omega$ ).
- Low battery indication.
- Auto power off (30 minutes).
- Range hold.
- Overload indication.
- Auto range.
- Data hold.
- Power supply.

#### DIMENSION

- Size : 195X64X30mm (LxWxH)
- Weight : 240g.

#### SPECIFICATIONS

Max measuring current	600A
Display counts	2000
Max conductor size	30 mm
AC Current	0.1A ~ 600A(Auto) $\pm$ (2.0%+5)
AC Voltage	0.1 ~ 600V $\pm$ (1.5%+5)
DC Voltage	0.1V ~ 600V $\pm$ (1.0%+2)
Resistance	0.1 ~ 200 $\Omega$ $\pm$ (0.8%+3)



AC 指針鉤錶

### YF-800

#### 300A ANALOG AC CLAMP METER DISPLAY

Rotary scales present one range at a time.

#### FUNCTIONS

- Function keys : pointer lock switch.
- Test ranges : ACV, ACA, Ohm.
- Zero adjustment screw.
- The maximum conductor size is 42mm.
- Inter magnetic version to prevent interference from magnetic field.

#### DIMENSION

- Size : 220X85X33mm (LxWxH)
- Weight : 340g (including battery).

#### SPECIFICATIONS

	Range	Accuracy	Input	Overload
ACV		(50Hz ~60Hz)	Impedance	Protection
	150V	+/- 3.0	2.1K Ohm/V	0.5A/250 Vrms
	300V			
	600V			
ACA		(50Hz ~60Hz)	--	Protection
	6A	i Ó 3.0	--	400A
	15A			
	60A			
	150A			
	300A			
Resistance	5K Ohm	+/- 3.0	--	0.5A/250 Vrms



電子式鉤錶

### YF-8020

#### 600A AC CLAMP METER DISPLAY

- 3-1/2 digits LCD with maximum reading 2000
- Low battery indication: "  "

#### FUNCTIONS

- Function keys : data hold.
- Test range : ACV, ACA, Ω.
- Data hold.

#### DIMENSION

- Size : 209X77X36mm (LxWxH)
- Weight : 260g.

#### SPECIFICATIONS

Max measuring current	600A
Display counts	2000
Max conductor size	35 mm
AC Current	0.01A ~ 600A ± (2.0%+5)
AC Voltage	0.1V ~ 750V ± (1.0%+3)
Resistance	1Ω ~ 2KΩ ± (1.0%+2)

### YF-8070

#### 600A AC CLAMP METER DISPLAY

- 3-1/2 digits LCD with maximum reading 2000
- Low battery indication: "  "

#### FUNCTIONS

- Function keys : data hold, peak hold.
- Test range : ACV, ACA, Ω, Hz, continuity.
- Continuity buzzer.
- Peak hold.
- Data hold.

#### DIMENSION

- Size : 221X62X35mm (LxWxH)
- Weight : 330g.

#### SPECIFICATIONS

Max measuring current	600A
Display counts	2000
Max conductor size	35 mm
AC Current	10mA ~ 600A ± (2.0%+5)
AC Voltage	0.1V ~ 750V ± (1.2%+3)
Resistance	1Ω ~ 2000Ω ± (1.0%+2)
Frequency	1Hz ~ 5MHz ± (0.8%+3)





## 乾燥過濾器

CHARGED WITH XH9 MOLECULAR SIEVE STRONGLY MOISTURE ABSORB AND CAN BE FOR R12, 22, 502 AND R134A



PART NO.	Fittings	Diameter(mm)	Length(mm)
FD-052	1/4"Flare	63	123
FD-053	3/8"Flare	63	135
FD-083	3/8"Flare	63	155
FD-164	1/2"Flare	63	200
FD-165	5/8"Flare	63	211
FD-052S	1/4"solder	63	119
FD-083S	3/8"solder	63	145
FD-164S	1/2"solder	63	193
FD-165S	5/8"solder	63	194

PART NO.	Fittings	Diameter(mm)	Length(mm)
CH-032	1/4"Flare	42	112
CH-052	1/4"Flare	58	119
CH-083	3/8"Flare	58	156
CH-084	1/2"Flare	58	169
CH-163	3/8"Flare	58	176
CH-164	1/2"Flare	58	184
CH-165	5/8"Flare	58	195
CH-089	3/8"MF	89	253
CH-052S	1/4"solder	58	104
CH-083S	3/8"solder	58	123
CH-164S	1/2"solder	58	155
CH-165S	5/8"solder	58	155

## 壓力開關 PRESSURE SWITCH



Part NO.	Type	Pressure Range kg/cm <sup>2</sup> LOW = 02 MID±0.5 HIGH±2			Heat Resistance	Working Pressure	Pressure Sureport	Voltage Inductive Load	Prerigerant
		2.0	· ·	· ·					
20100	Low male switch	2.0	· ·	· ·	100°C	30Kg/cm <sup>2</sup>	45Kg/cm <sup>2</sup>	DC12V3.5A	R12
20200	Binary male switch	2.0	· ·	26.5	100°C	30Kg/cm <sup>2</sup>	45Kg/cm <sup>2</sup>	DC12V3.5A	R12
20210	Binary male switch	2.0	· ·	24	100°C	30Kg/cm <sup>2</sup>	45Kg/cm <sup>2</sup>	DC12V3.5A	R12
23202	Binary male switch	2.0	· ·	32	100°C	30Kg/cm <sup>2</sup>	45Kg/cm <sup>2</sup>	DC12V3.5A	R134A
23203	Binary male switch	2.0	· ·	28	100°C	30Kg/cm <sup>2</sup>	45Kg/cm <sup>2</sup>	DC12V3.5A	R134A
23204	Binary male switch	2.0	· ·	27	100°C	30Kg/cm <sup>2</sup>	45Kg/cm <sup>2</sup>	DC12V3.5A	R134A
23205	Binary male switch	2.0	· ·	32	100°C	30Kg/cm <sup>2</sup>	45Kg/cm <sup>2</sup>	DC12V3.5A	R134A
20206	Binary female switch	2.0	· ·	26.5	100°C	30Kg/cm <sup>2</sup>	45Kg/cm <sup>2</sup>	DC12V3.5A	R12
20207	Binary female switch	2.0	· ·	24	100°C	30Kg/cm <sup>2</sup>	45Kg/cm <sup>2</sup>	DC12V3.5A	R12
23208	Binary female switch	2.0	· ·	28	100°C	30Kg/cm <sup>2</sup>	45Kg/cm <sup>2</sup>	DC12V3.5A	R134A
23209	Binary female switch	2.0	· ·	32	100°C	30Kg/cm <sup>2</sup>	45Kg/cm <sup>2</sup>	DC12V3.5A	R134A
30020	Relay	12V	20A	200A MAX current		500V UP insulating			
30021	Relay	12V	20A	200A MAX current		500V UP property			



▶▶ YL-4301  
Solenoid Valve



▶▶ YL-5041  
Fan switch



▶▶ YL-6602

Nominal voltae : DC 12V  
Load : 1A  
Cuurrent : 0.2V  
A/type : DC 12V  
B/type : DC 24V

\*\* Special length are also available.\*\*

# 液氣分離器 REFRIGERANT ACCUMULATOR

## INSTALLATION INSTRUCTIONS

1. Vertically mounted only.
2. Install as close to the compressor as possible.
3. Suction line from evaporator into inlet connection installed to suction line of compressor.
4. Reverse cycle systems required.  
Accumulator to be installed between the compressor and the reversing valve.
5. Keep direct flame away from fusible relief device while soldering connections.
6. Safe working pressure 450 PSI.

Maximum recommended actual tons based on pressure drop through accumulator equivalent to 1/2°F minimum recommended actual tons based on minimum flow through accumulator necessary to insure positive oil return.

All data is based on actual tons and bears no relationship to horsepower.

Minimum evaporator temperature -40°F.

Minimum suction gas temperature through accumulator + 10°F.



Item NO.	Size Conv. ODE	B Length Inches	A Dia. Inches
RA-204	1/2	8	4
RA-205	5/8	10-5/8	4
RA-206	3/4	9	5-1/2
RA-207	7/8	12	5-1/2
RA-208	1-1/8	15	6-1/2
RA-209	1-3/8	20	6-1/2
RA-210	1-5/8	22	6-1/2
RA-221	2-1/8	29	8-5/8

# 過濾乾燥筒 & 油分離器 REPLACEABLE CORE TYPE DRIER & OIL SEPARATOR

## ▶▶▶ CD-1101

These devices offer the flexibility of using either replaceable filter cores as protection against solid.

Contaminants, or replaceable filter-drier blocks for protection against acid, moisture, and solids.

They provide high liquid line flow capacities for larger air-conditioning and refrigeration jobs. Some key features of the demountable series :

- Simplified internal hardware for easy installation.
- Full flow fittings for low pressure drop.
- Corrosion - resistant epoxy paint finish.
- Sturdy steel shells for long life durability.
- Safe working pressure 500 PSIG.
- Burst pressure 2500 PSIG.



## ▶▶▶ S-5200

Separator's function is to help refrigeration and air conditioning systems operate more efficiently and save energy.

In any refrigeration system, refrigerant and oil are always present. Certain amounts of oil will always leave the compressor crank-case with refrigerant gas.

The oil separator separates the oil from the refrigerant and returns it to the compressor crank-case before it can enter other components of the system.

The less oil in circulation in a refrigeration system, the more refrigerant available for cooling, This increases the efficiency of a system by reducing running time and lowering operating cost. Safe working pressure-450PSIG.



Item NO.	Conn-ection Type	Dimen A	Dimen B
CD - 1100	5/8" ODS	8-3/4	5-1/2
CD - 1101	3/4" ODS	8-3/4	5-1/2
CD - 1102	7/8" ODS	8-7/8	5-5/8
CD - 1103	1-1/8" ODS	9-3/16	5-15/16
CD - 1104	1-3/8" ODS	9-5-16	6
CD - 1105	1-5/8" ODS	9-9-16	6-1/4
CD - 1106	2-1/8" ODS	9-9-16	6-1/4
CD - 2202	7/8" ODS	14-1/2	11-1/4
CD - 2203	1-1/8" ODS	14-13/16	11-9/16
CD - 2204	1-3/8" ODS	14-13/16	11-9/16
CD - 2205	1-5/8" ODS	14-5/16	11-11/16
CD - 2206	2-1/8" ODS	15-7/6	12-3/6
CD - 3303	1-1/8" ODS	20-3/8	17-1/8
CD - 3304	1-3/8" ODS	20-3/8	17-1/8
CD - 3305	1-5/8" ODS	20-1/2	17-1/4
CD - 3306	2-1/8" ODS	21	17-3/4
CD - 4404	1-3/8" ODS	25-13/16	22-9/16
CD - 4405	1-5/8" ODS	26-13/16	22-11/16
CD - 4406	2-1/8" ODS	26-7/19	23-3/6

## Dimenslons - inches

Item NO.	DCI NO.	Size Conn.	length.	DIA. Inches
S-5200	5201S	1/2" ODS	7-1/2	4
	5201	1/2" ODS	10-1/4	
	5202	5/8" ODS	14-1/4	
	5203	7/8" ODS	16-3/4	
	5204	1-1/8" ODS	18	
S-5300	5205	1-3/8" ODS	19	4
	5302	1/2" ODS	10-1/4	
	5303	5/8" ODS	14-1/4	
	5304	7/8" ODS	14-3/4	
	5305	1-1/8" ODS	18	
S-6200	5306	1-3/8" ODS	19	6
	5307	1-5/8" ODS	19	
	6202	1-1/8" ODS	14-1/2	
	6203	1-3/8" ODS	16	
S-6300	6204	1-5/8" ODS	17-1/4	6
	6205	2-1/8" ODS	19	
	6302	1-1/8" ODS	14-1/2	
	6303	1-3/8" ODS	16	
	6304	1-5/8" ODS	17-1/4	6
	6305	2-1/8" ODS	19	

# 儲液器 & 冷熱交換器

## REFRIGERATION RECEIVER & HEAT-EXCHANGER



Vertical receivers supply you with best choice for your refrigeration system which the receivers needed verticalmount.

They offer 500 p.s.i.g. safe working pressure.

Refer to the specification while ordering.

Each size has up outlet and down outlet.

General use is up outlet model.

高壓



Offers the complete line of strong construction of suction accumulators which provide you with the largest capacity of protection against rust.

All heat exchanger-suction accumulators are complete with RR362 fusible plug installed.

Please refer to the specifications listed below while ordering.

Item NO.	Dimension (inches)		Connection size	
	DIA.	H.	IN.	OUT.
CR-101	3-3/8	8-3/4	3/8	1/4
CR-102	5	9-5/8	3/8	3/8
CR-103	5	11-1/2	3/8	3/8
CR-104	6	13-3/4	1/2	1/2
CR-105	7	17	5/8	5/8
CR-106	6-1/2	20-7/8	3/4	3/4
CR-107	6-1/2	28-3/4	7/8	7/8

Item NO.	DIA inch	Length Inches.	Suction Line I.D.	Liquid Line I.D.
SAV-2404	4	8-1/2	1/2	3/8
SAV-2405	4	10-5/8	5/8	3/8
SAV-2406	5-1/2	10	3/4	3/8
SAV-2407	5-1/2	13	7/8	1/2
SAV-2411	6-1/2	15-3/4	1-1/8	3/4
SAV-2413	6-3/4	20	1-3/8	3/4
SAV-2415	6-3/4	23	1-5/8	3/4
SAV-2417	8-5/8	29	2-1/8	7/8

## 圓管冷卻器

### SHELL AND TUBE REFRIGERANT CONDENSER

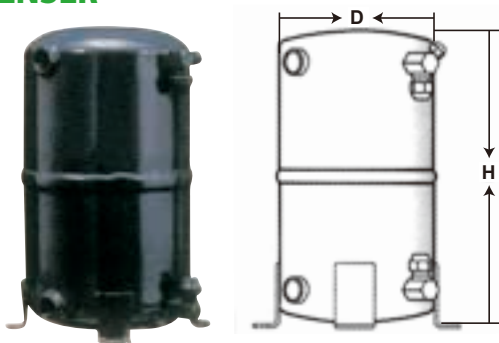

Item NO.	Flow capacity tons	Dimension (Inch)		Overall dimensions (inches)		Weight (Kg)
		D	H	Refrigerant Tube In/Out	Water Tube In/Out	
ST-6101	1	6	10-1/4	3/8" SAE	1/2" ODF	4.4
ST-6102	2	6	11-3/4	3/8" SAE	1/2" ODF	5
ST-6103	3	8	13-3/4	1/2" SAE	3/4" ODF	8.8
ST-6105	5	8-5/8	18	5/8" SAE	1" ODF	21.5

## 套管式冷卻器

### DOUBLE TUBE CONDENSER



Item NO.	Flow capacity tons	Cooper tubing connection		Overall dimensions (inches)		
		Refrigerant Tube size in/out	Water Tube size in/out	Body Length (L)	Hight (D)	Width (W)
DT-5201	1	1/2" ODS	3/4" ODS	10"	6-7/8"	9"
DT-5202	2	1/2" ODS	3/4" ODS	13"	7-3/4"	9"
DT-5203	3	1/2" ODS	1/2" ODF	14-1/2"	8-3/4"	9"
DT-5205	5	5/8" ODS	1" ODF	17-1/2"	16-1/2"	9"
DT-5207	7.5	7/8" ODS	1-1/4" ODF	26-1/2"	19-3/4"	9"
DT-5210	10	7/8" ODS	1-1/2" ODF	26-1/2"	23-5/8"	9"

## 保溫管

### INSULATION PIPE



▶▶▶ **AP-701**  
Each pc 6ft length I.D. from 1/4"~2-1/8" Wall thickness from 3/8"~1"

## 保溫片

### INSULATION SHEET

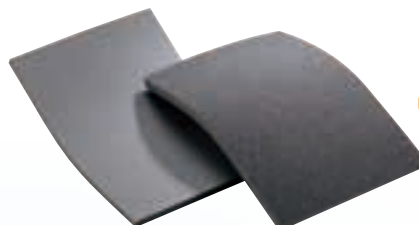

▶▶▶ **AP-702**  
Closed cell, black color L x W is 3" x 4" Thickness from 1/8"~1"

## 保溫膠帶

### INSULATION TAPETAPE



▶▶▶ **AP-703**  
1/8" x 2" x 30 meter

## 軟木膠帶

### TAR CORK TAPE



▶▶▶ **CT-302**  
1/8" x 2" x 30 meter